

# Instrukcja montażu

## Assembly instructions

### Amino Wardrobe

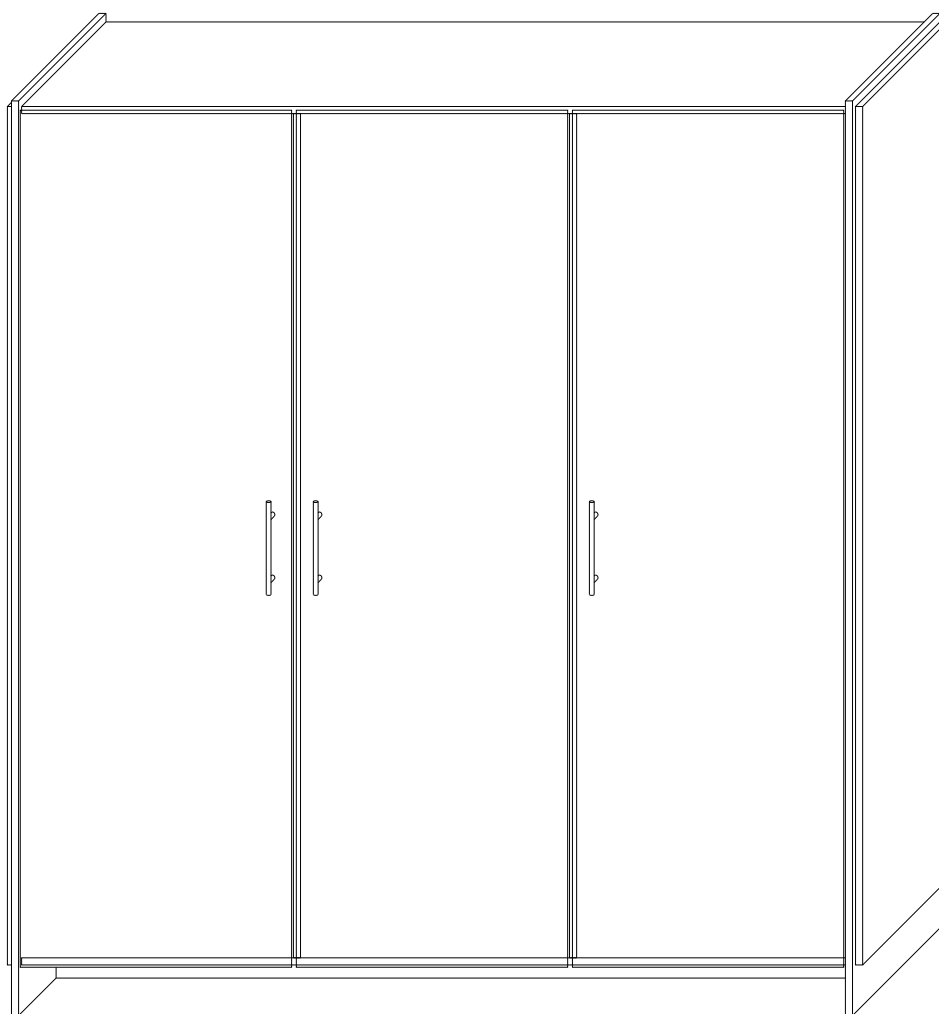





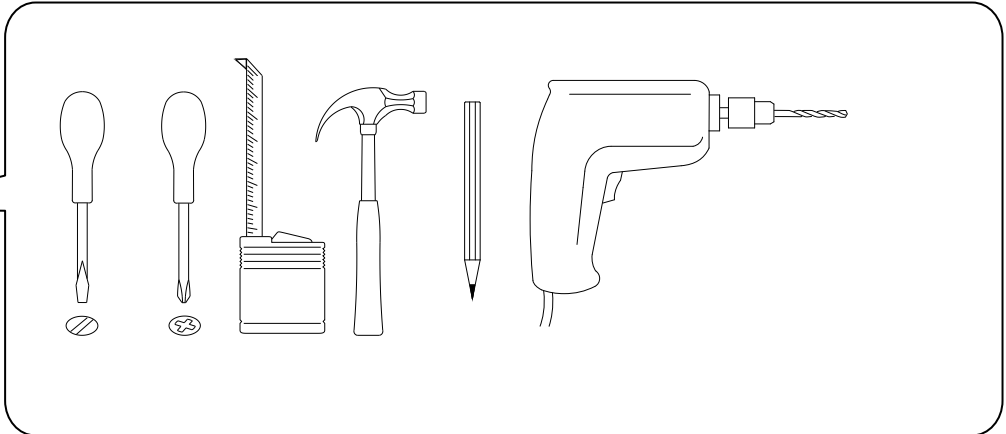
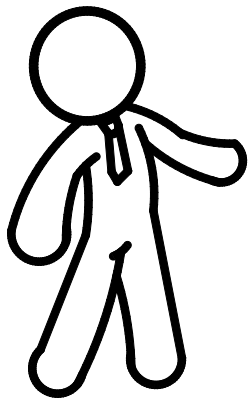
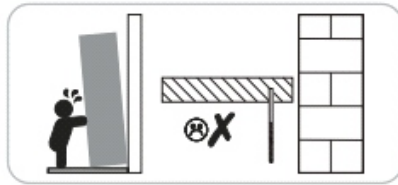
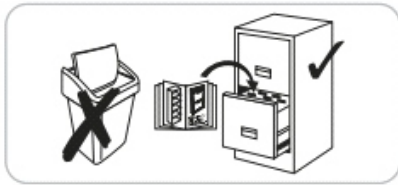
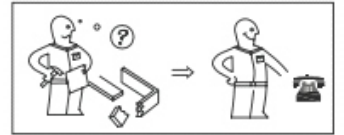
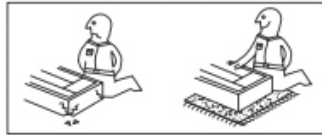
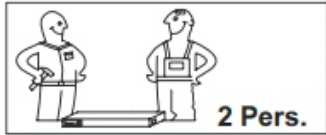



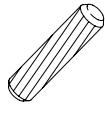

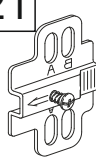
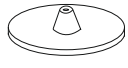



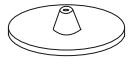
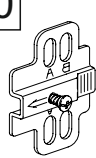
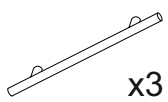

**mebelbos**

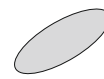
MEBEL BOS sp. z o.o. Chmiełek 204, 23-412 Łukowa, woj. lubelskie, Poland, Wpisana do rejestru przez Sąd Rejonowy Lublin-Wschód w Lublinie z siedzibą w Świdniku, VI Wydział Gospodarczy Krajowego Rejestru Sądowego nr (KRS) 0000417809, Kapitał zakładowy: 500.000,00 zł, NIP: 918-216-12-73, Reg: 061404000, tel/fax. +48 84 685 51 05, mebelbos@mebelbos.pl, www.mebelbos.pl

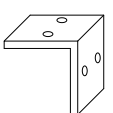

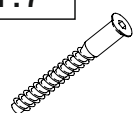
Packet	No	Lenght	Width	Qty
<b>No1</b>	7	572*	455	2
	8	572*	440	4
	Clothes lever		560	2
	Fittings			1
<b>No2</b>	1	1740**	500	1
	4	1803**	500**	2
<b>No3</b>	1	1740**	500	1
	2	1921**	518*	1
	3	1921**	518*	1
<b>No4</b>	5	1773*	480	1
	6	1773*	480	1
	9	571**	1800**	1
	10	1740	100	1
<b>No5</b>	9	571**	1800**	2
	11	1783	583	3

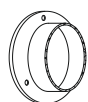
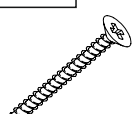
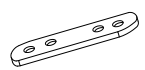
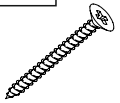
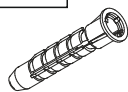
1.14  x21	1.16  x18	1.17  x18	1.21  x4	1.30 wood color  x16	
1.47 4x25mm  x16	2.69 5x12mm  x16	2.02  x36	2.61  x18	1.9  x7	2.68 black color  x2
1.20  x8	1.59  x3	1.2  x6	1.85 black color  x16	1.5 3,5x16mm  x120	
1.62  x2	1.32  x16	1.8  x8	1.7  x8	1.6  x1	1.15  x4
1.33 4x50mm  x2	1.58 60mm  x2	1.49 3,5x30mm  x2	1.36 8x40mm  x2		

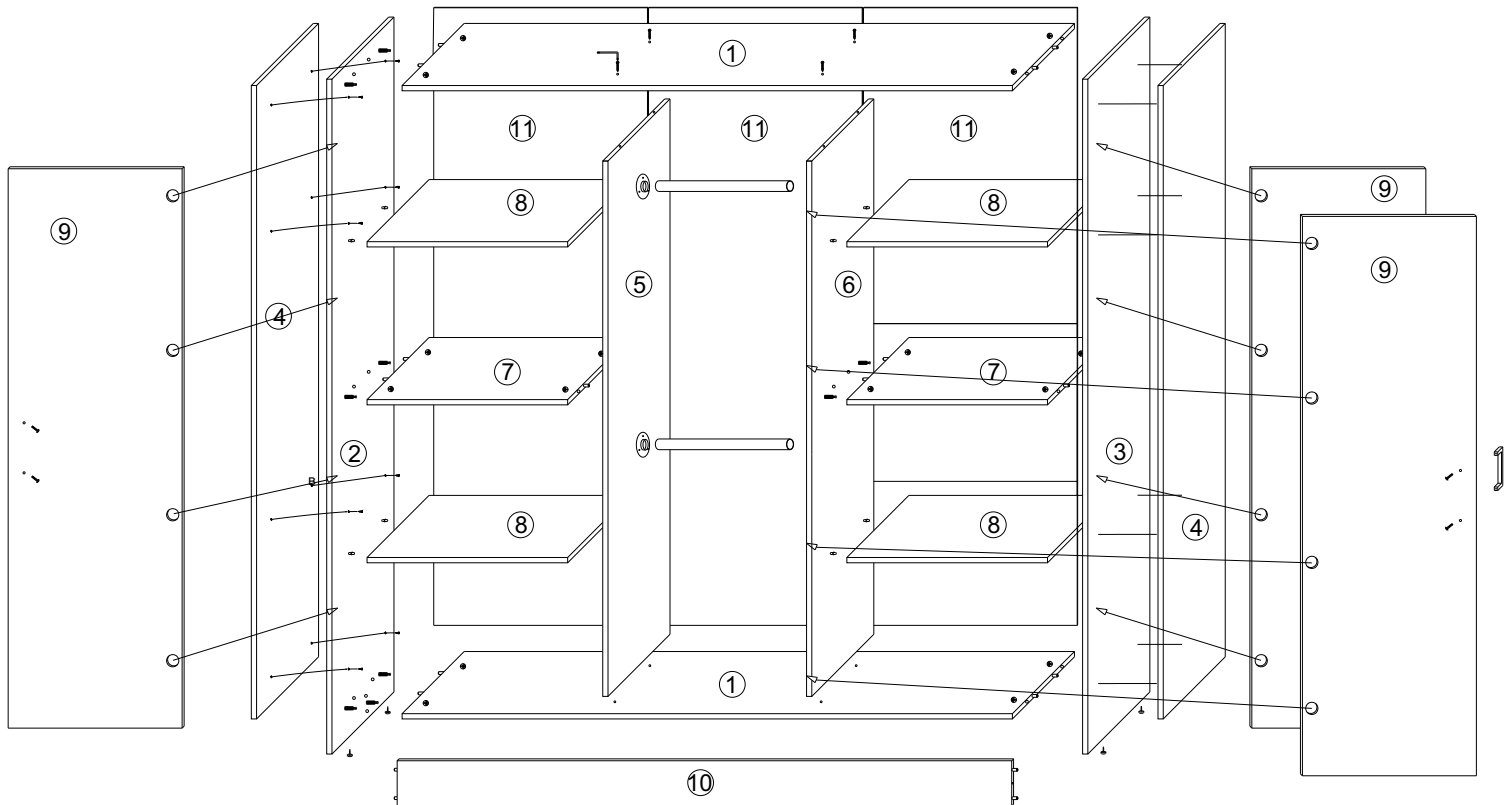

# 1

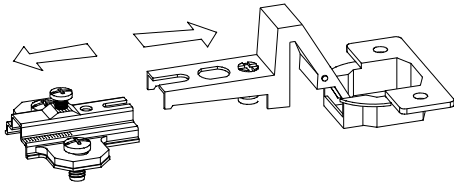

1.20 x8

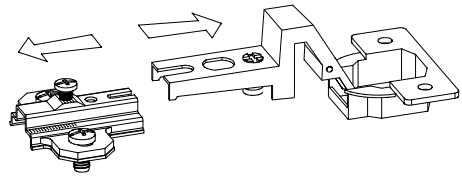

1.21 x4

# 2

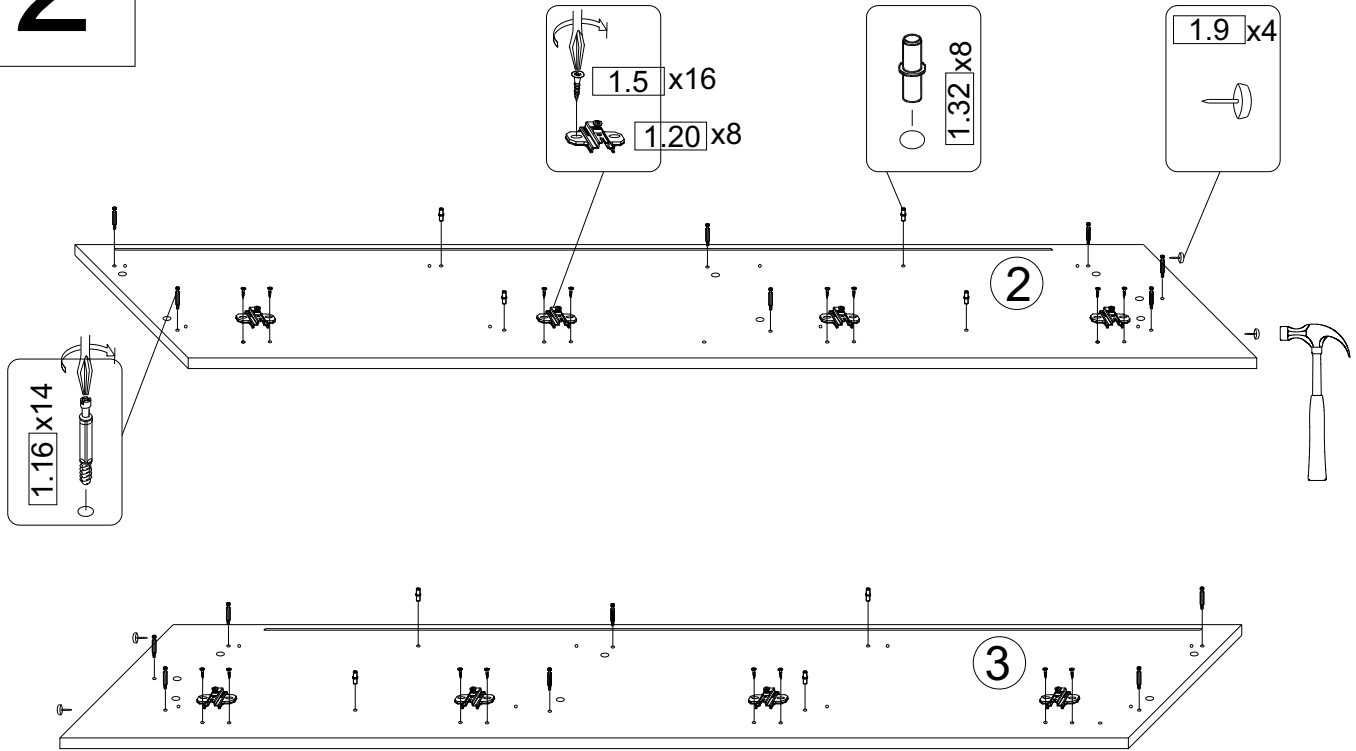

# 3 x2

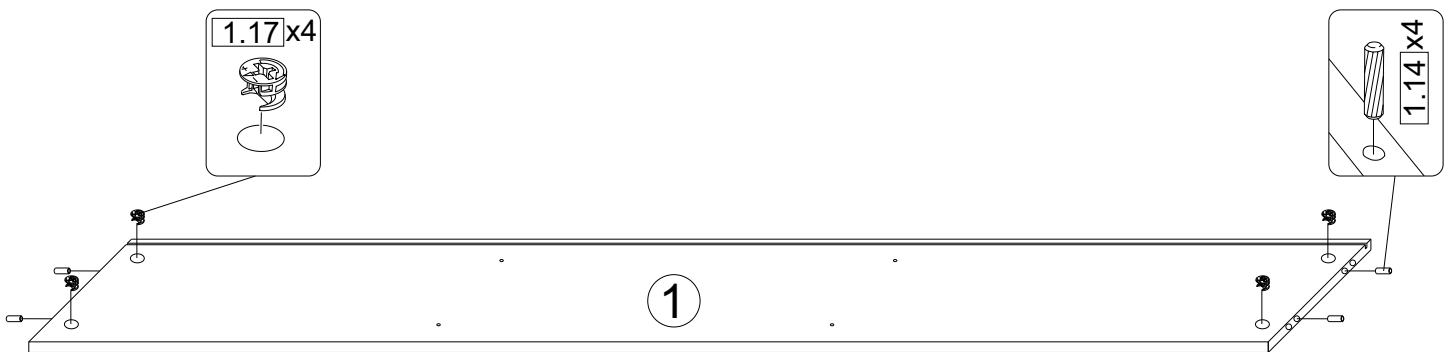

4

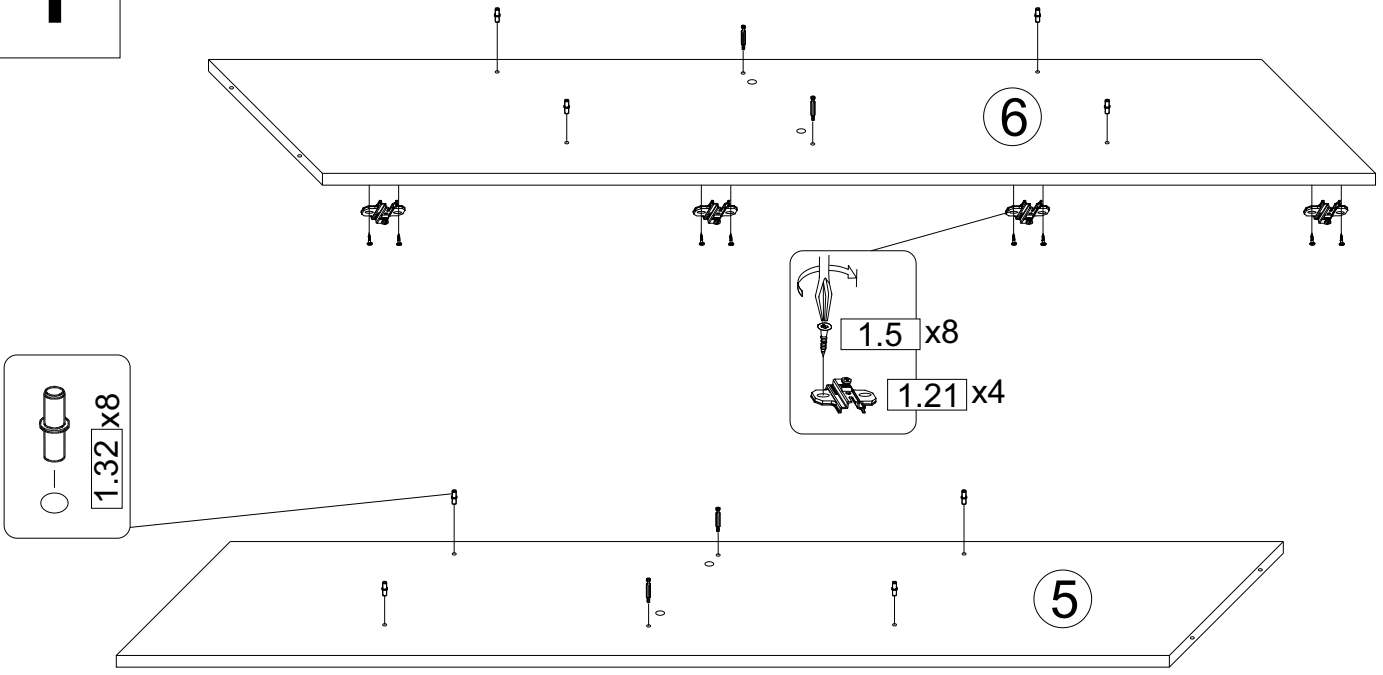

5

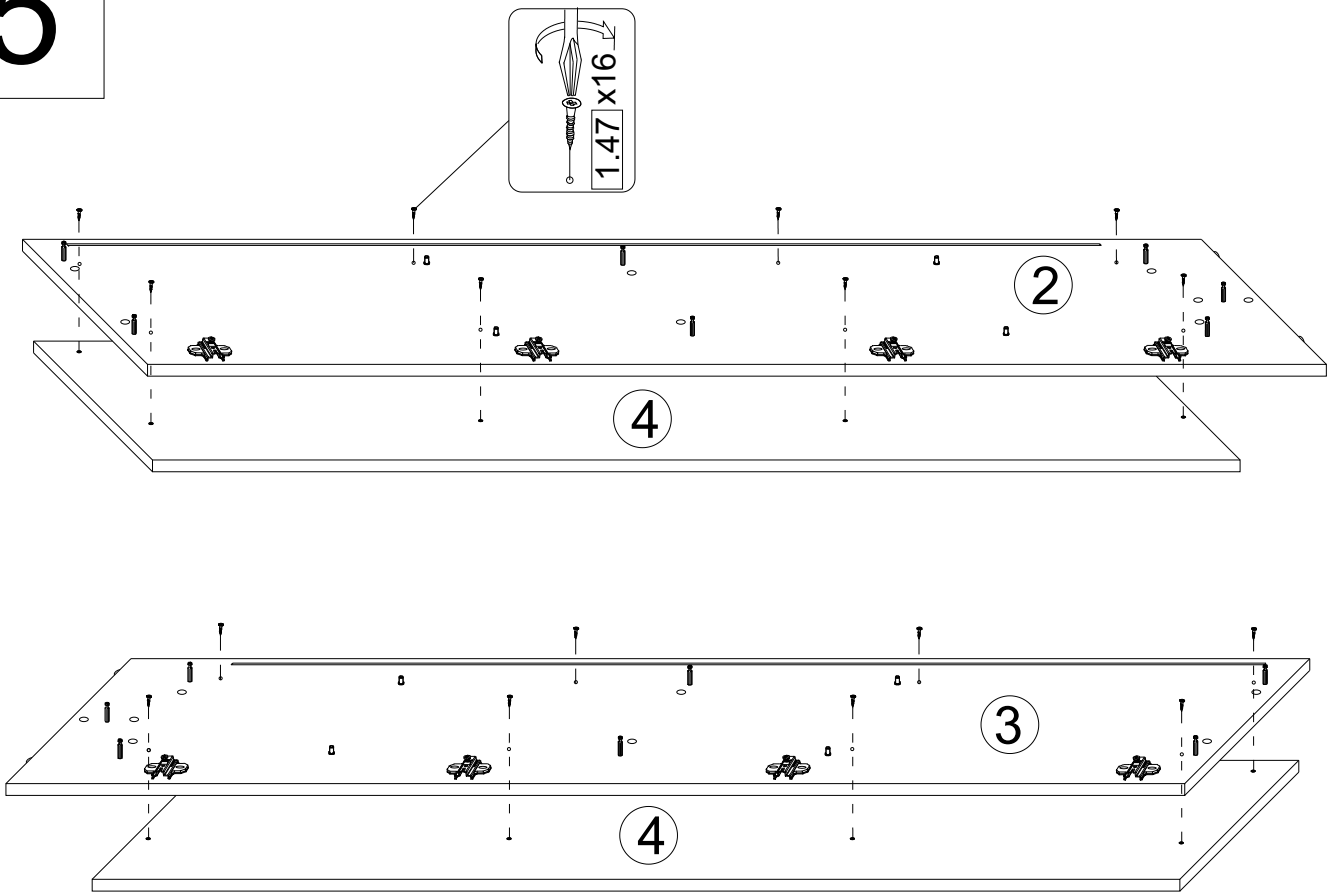

6

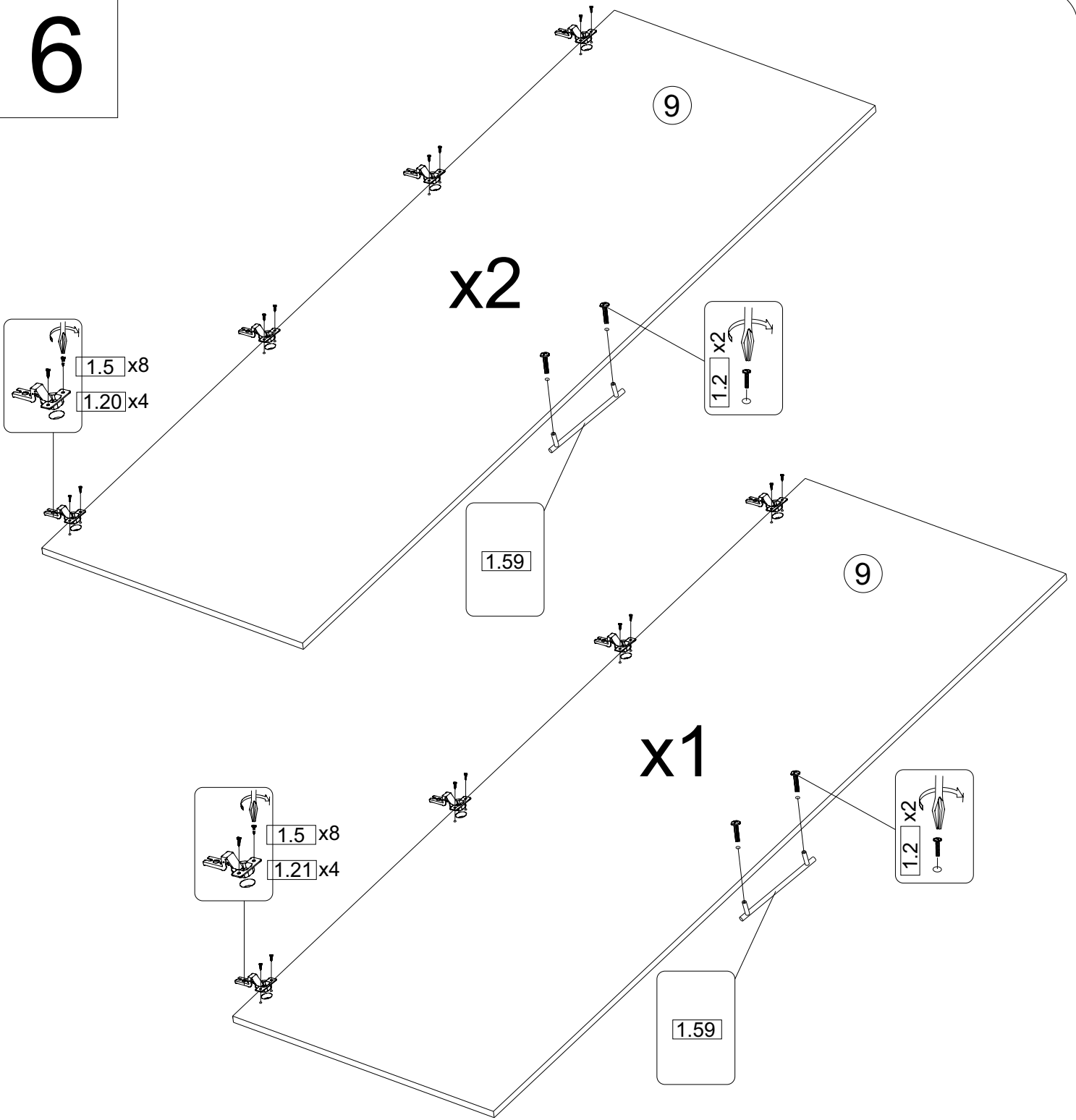

7

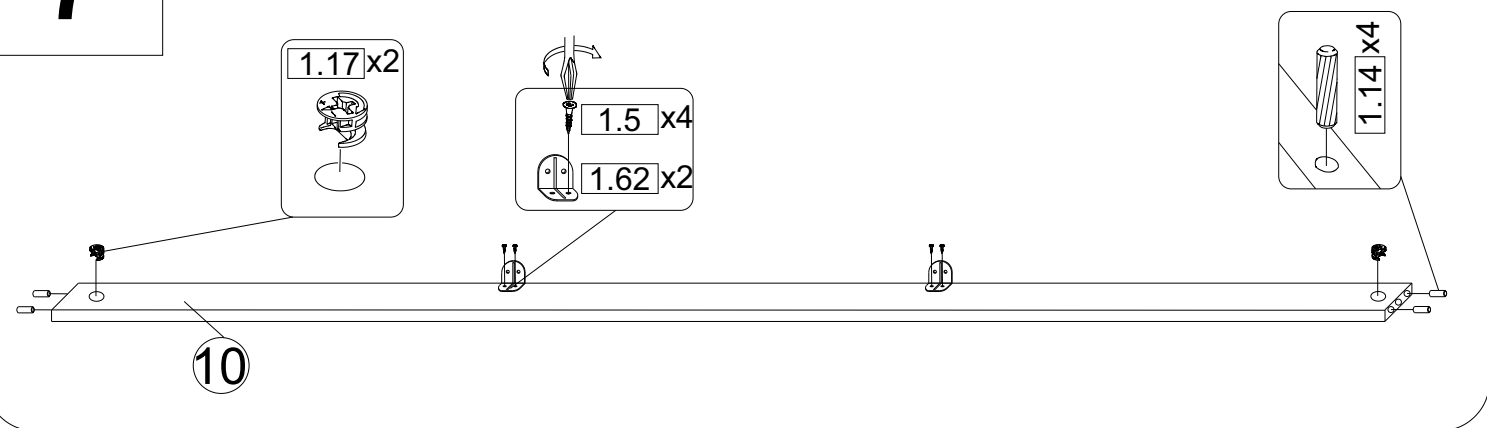

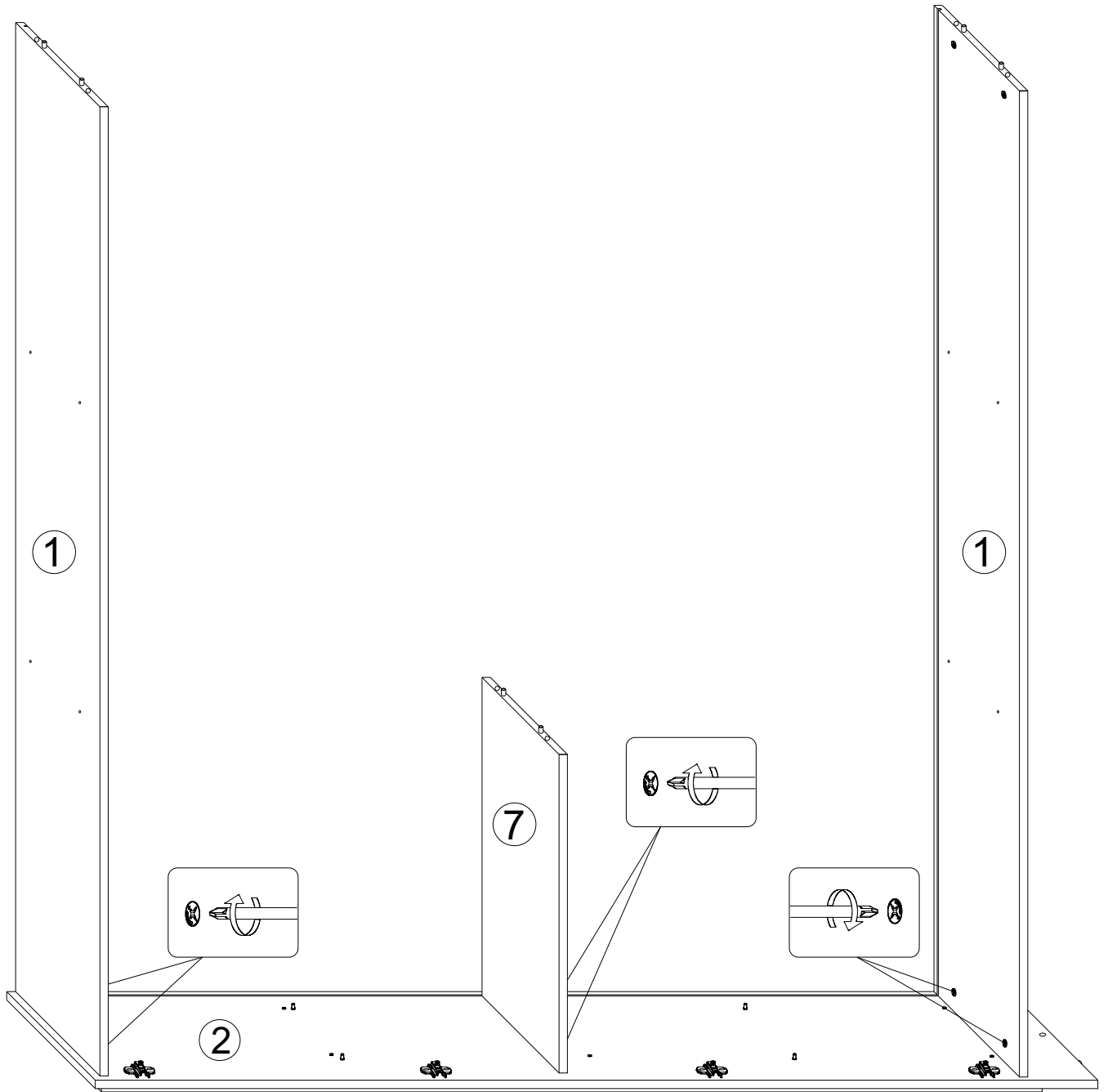

# 9

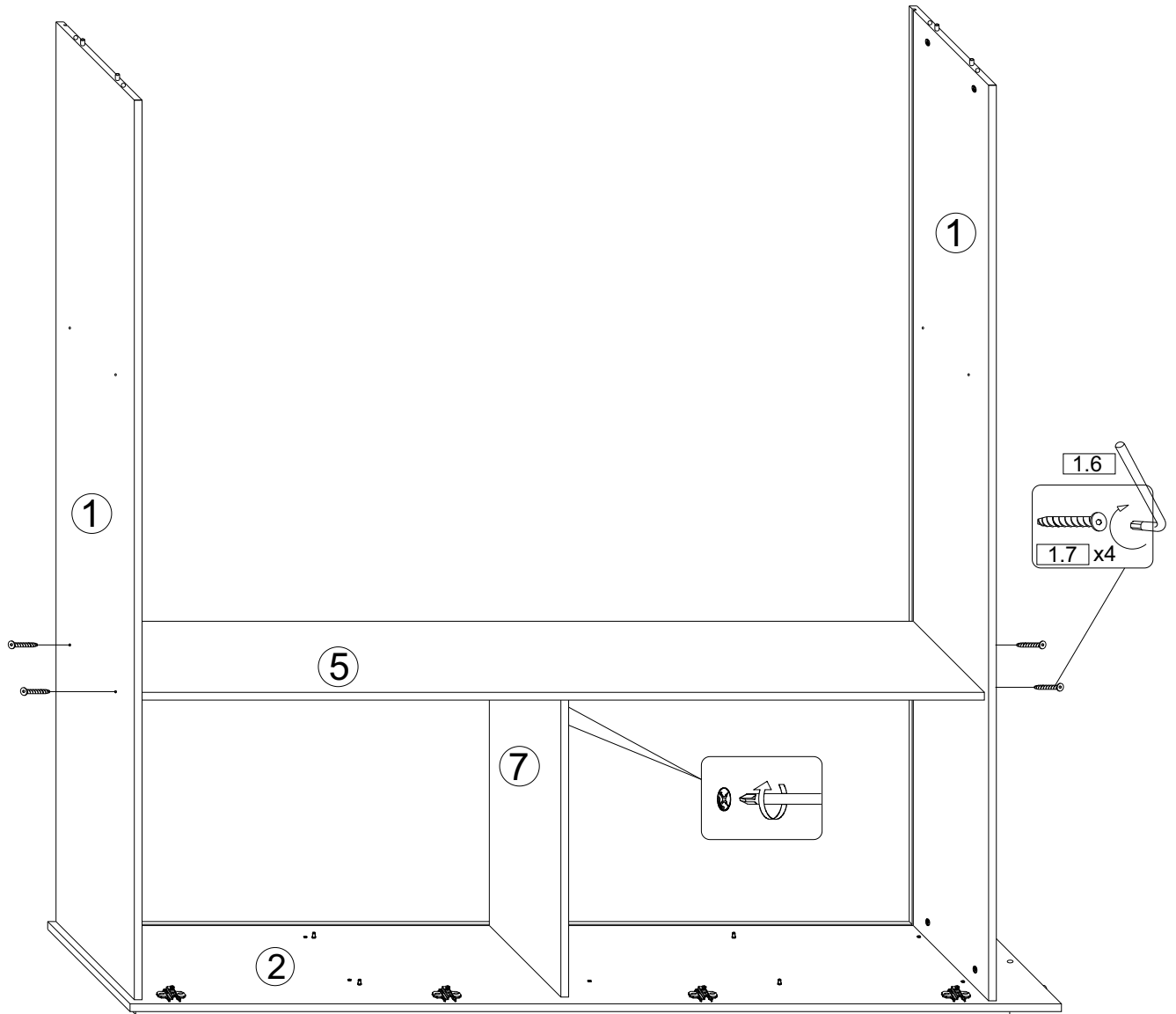

# 10

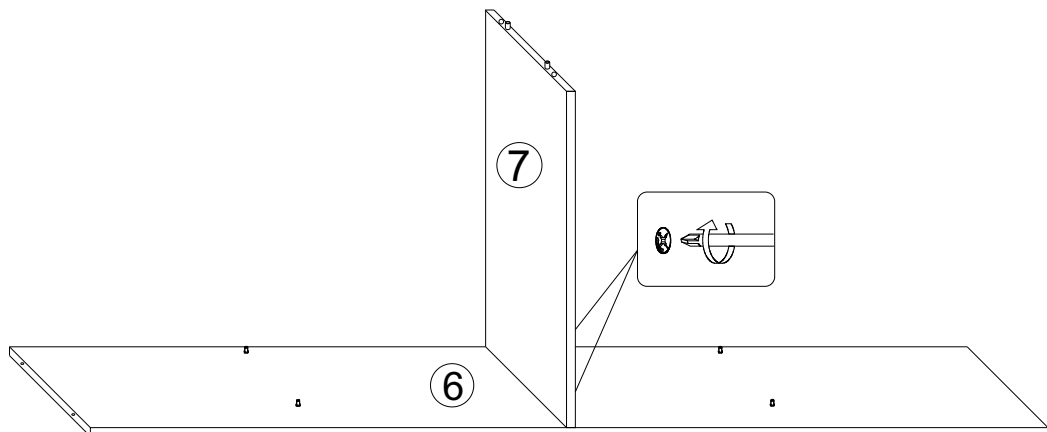



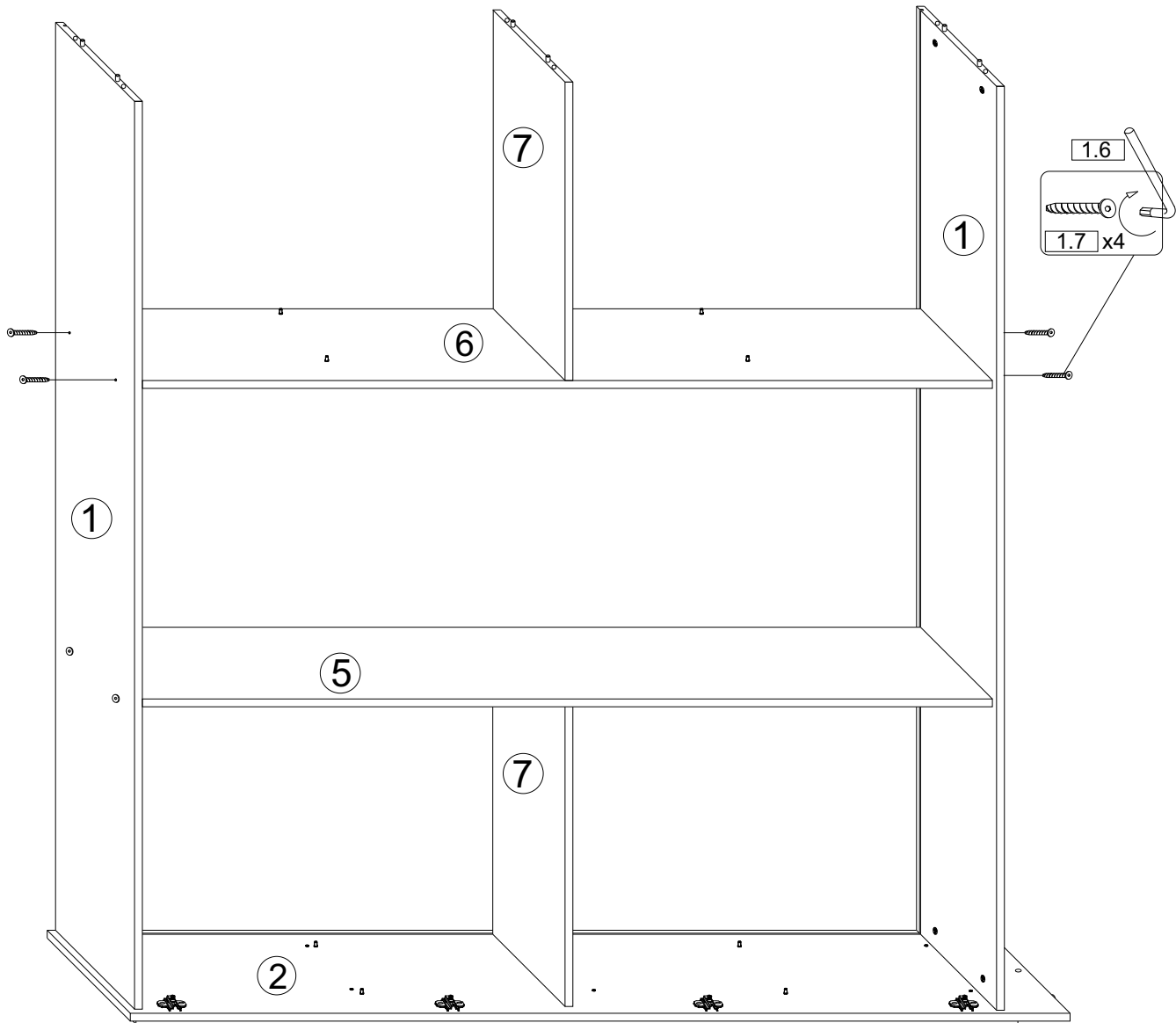

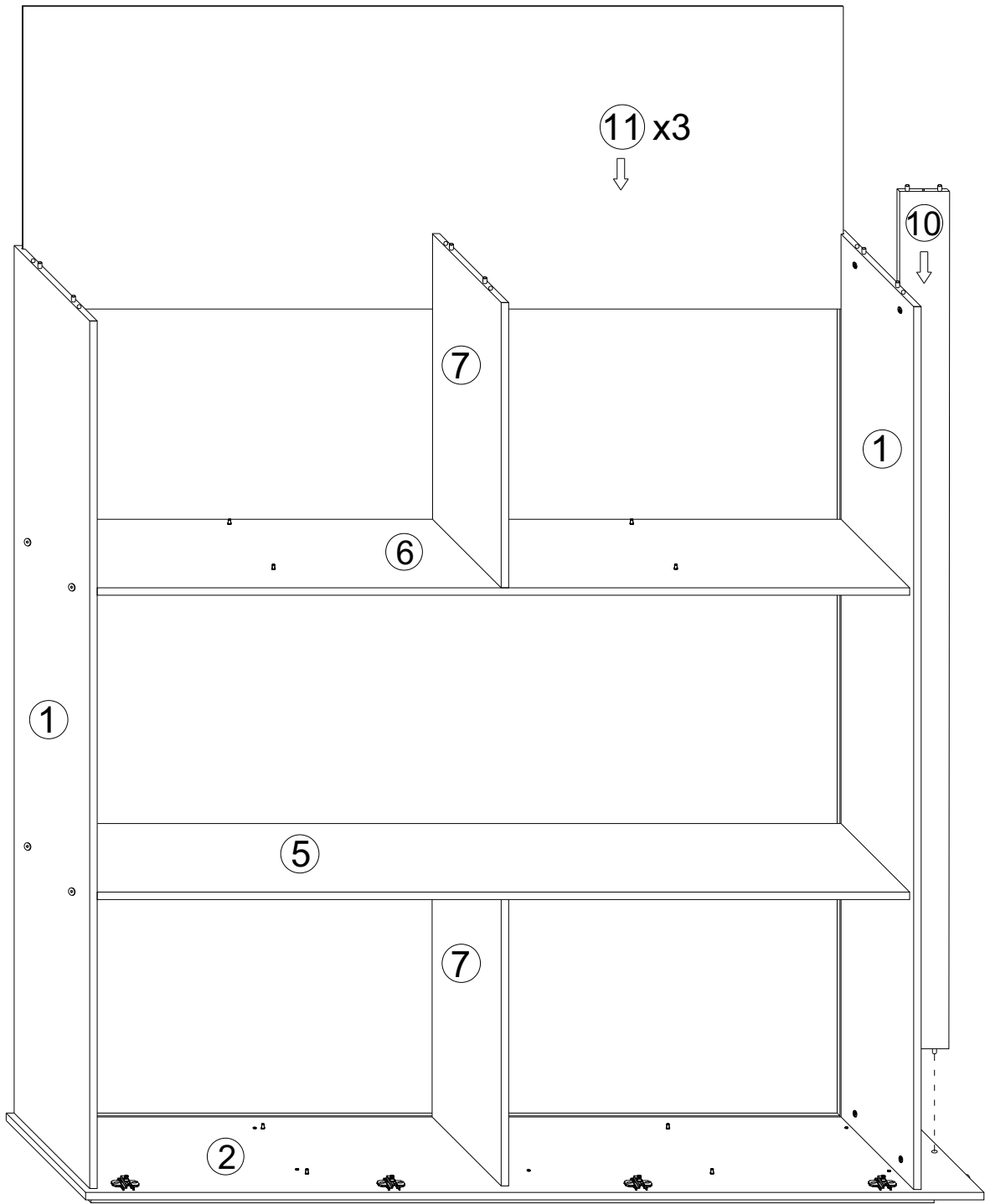

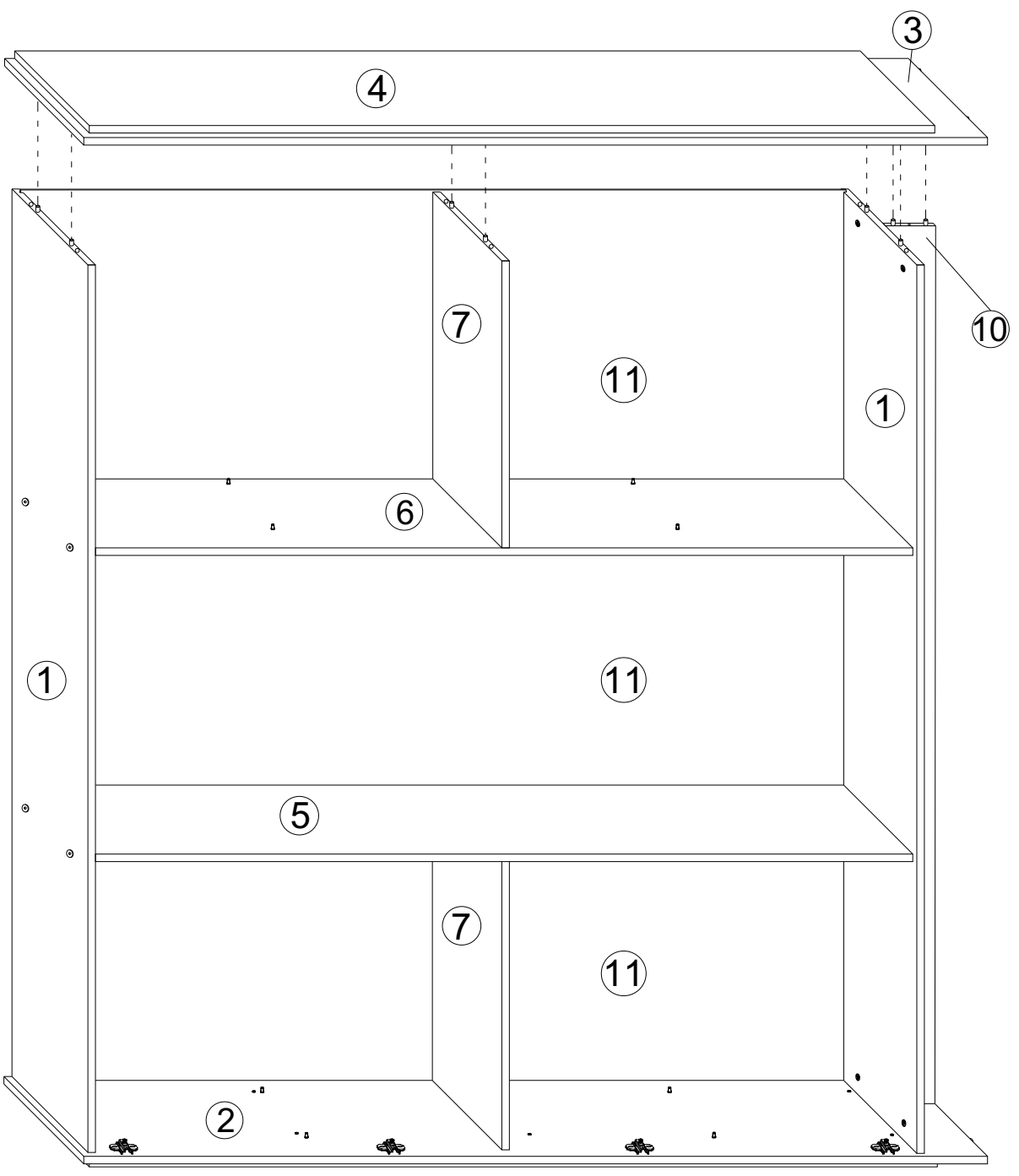

# 14

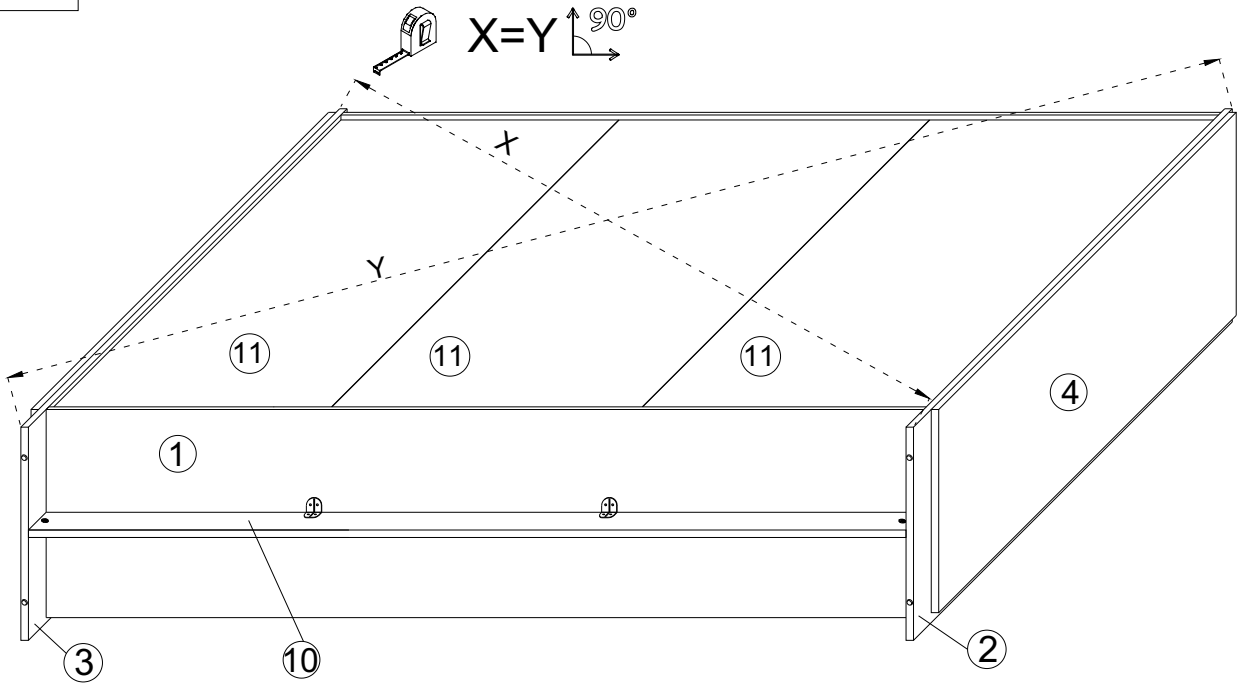

# 15

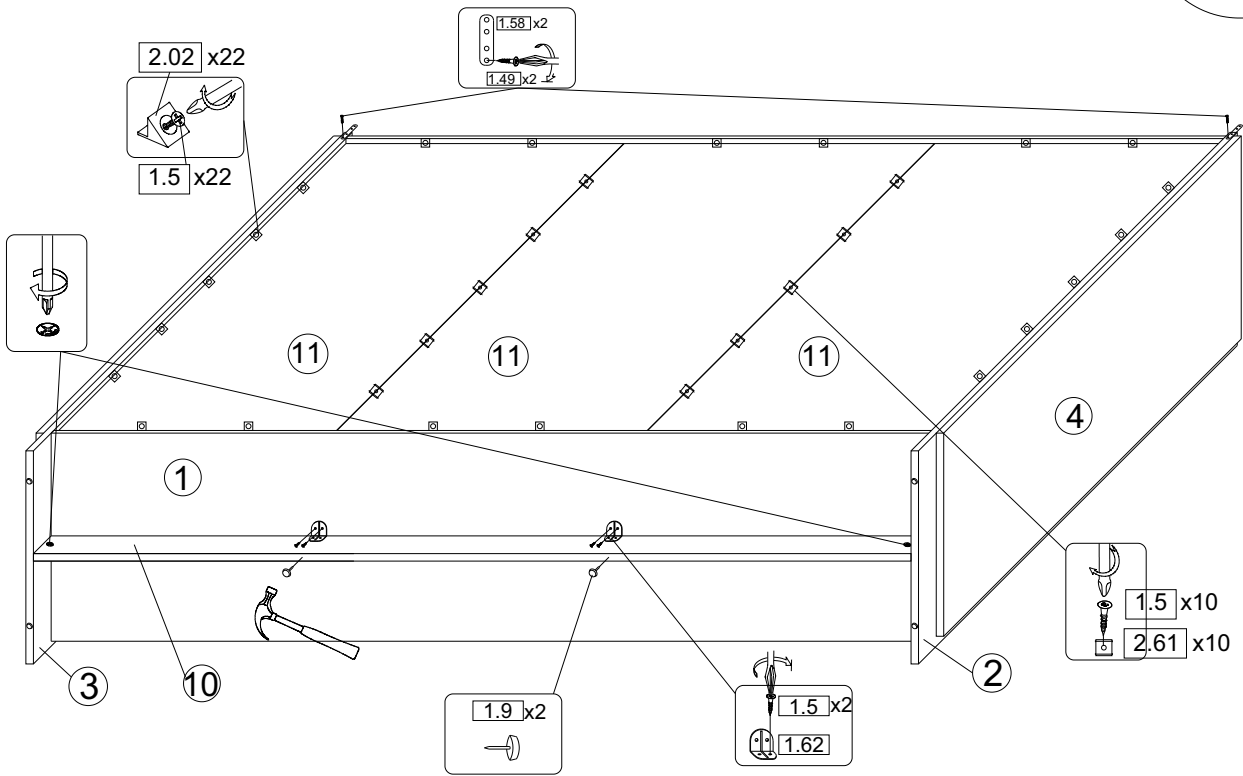
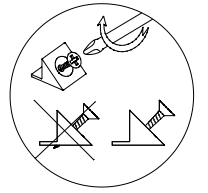

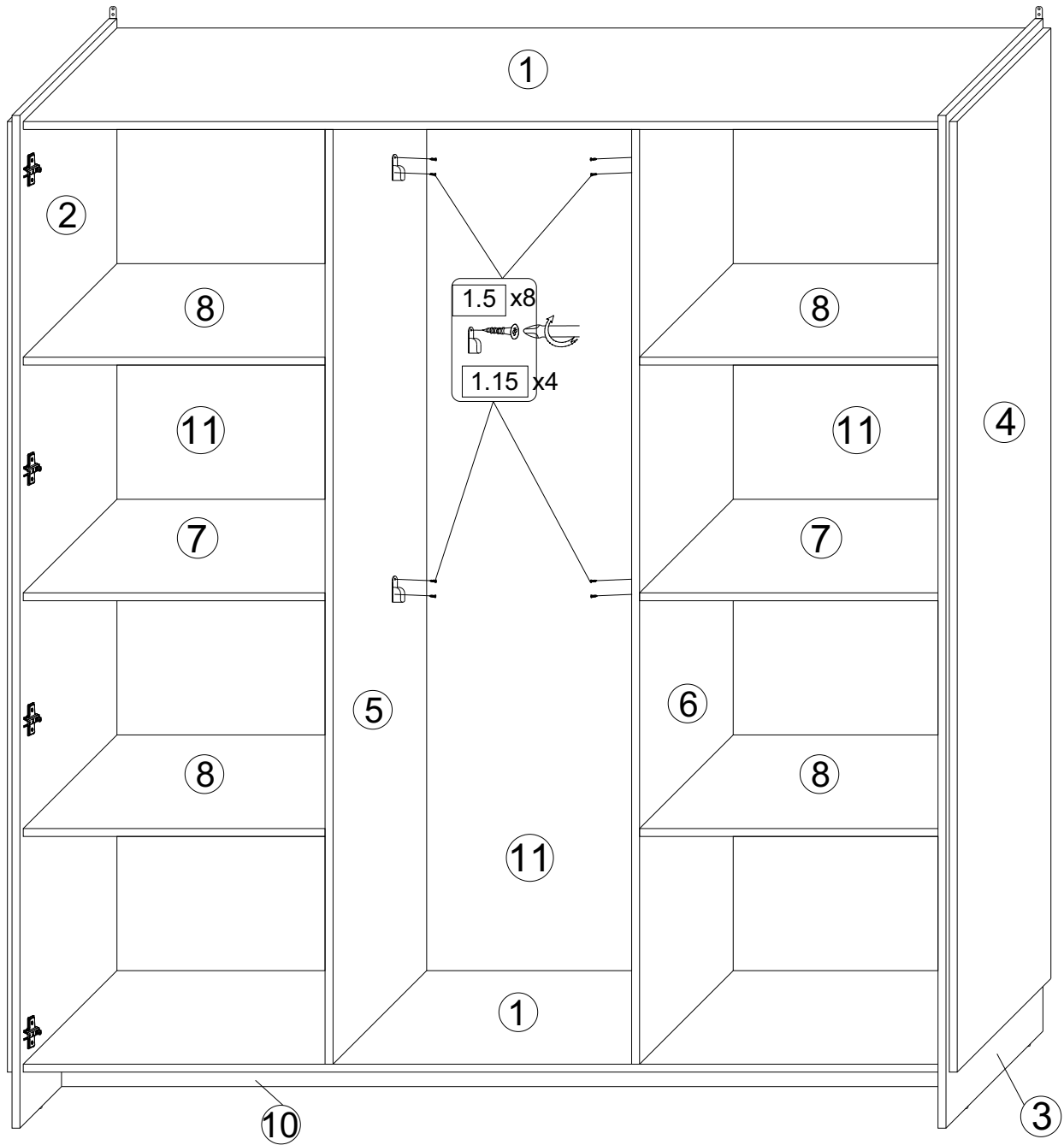

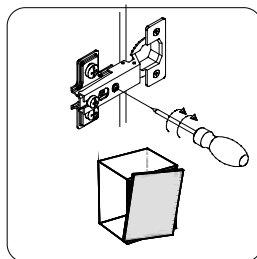
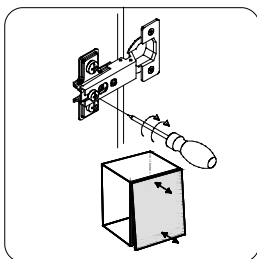
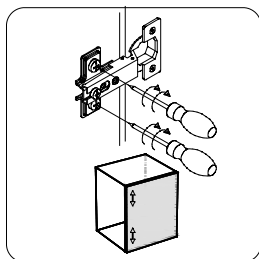
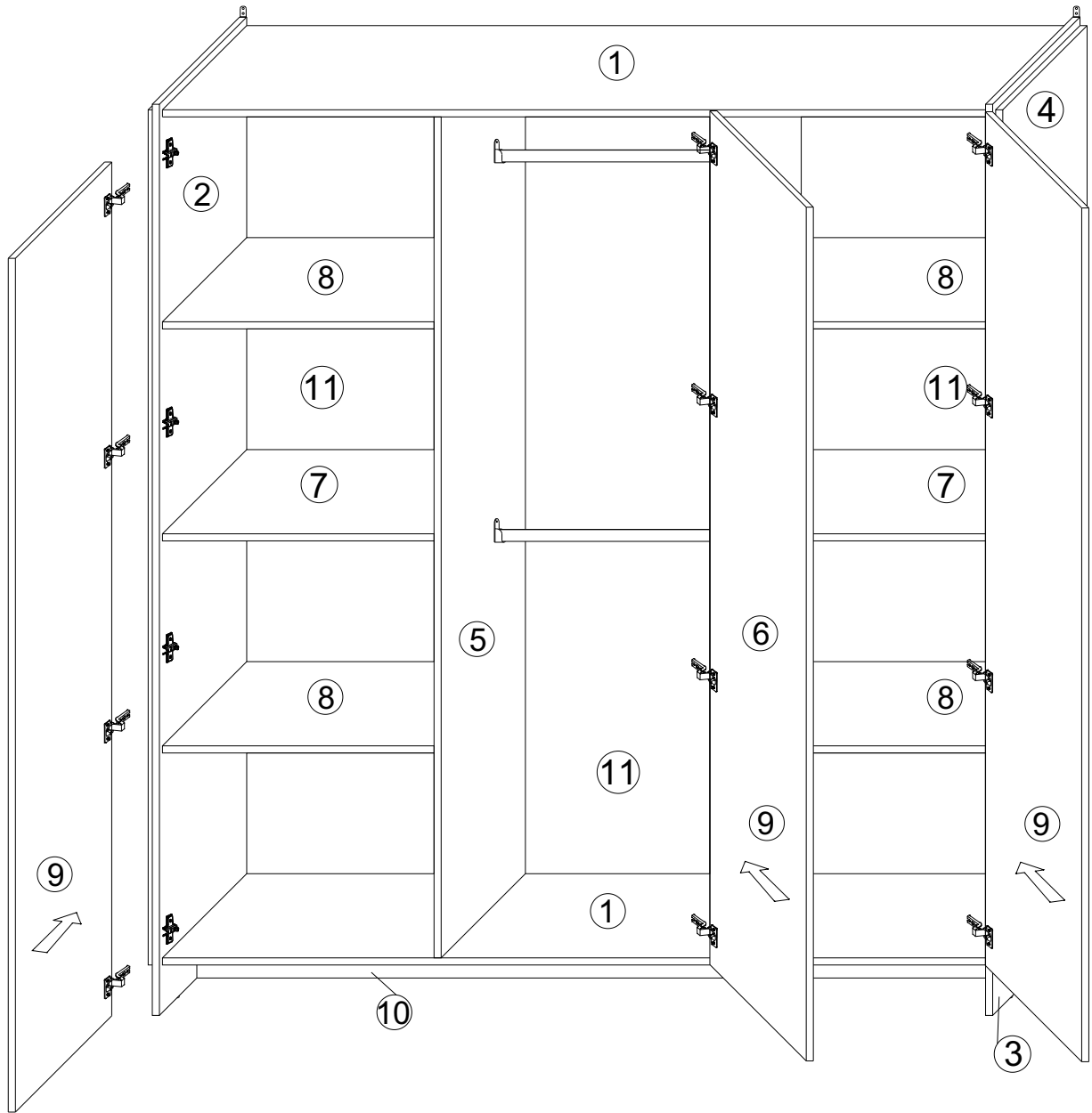
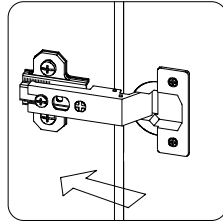

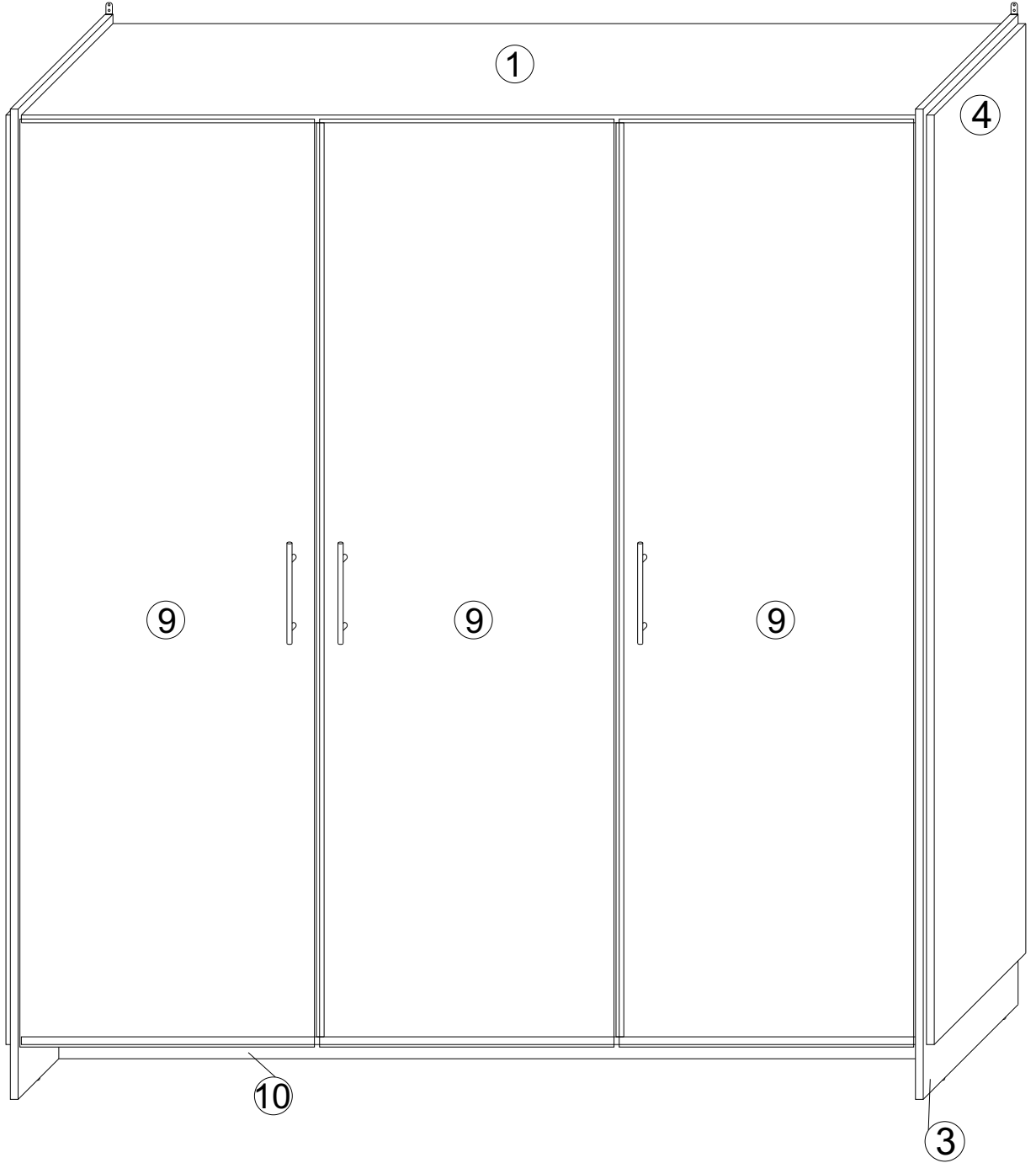

Always attach the furniture to the wall using stops! For wall mounting, use dowels appropriate to the material the wall is made of, if not If you are unsure, contact a specialist. Ultimately, the installer is responsible for the fasteners

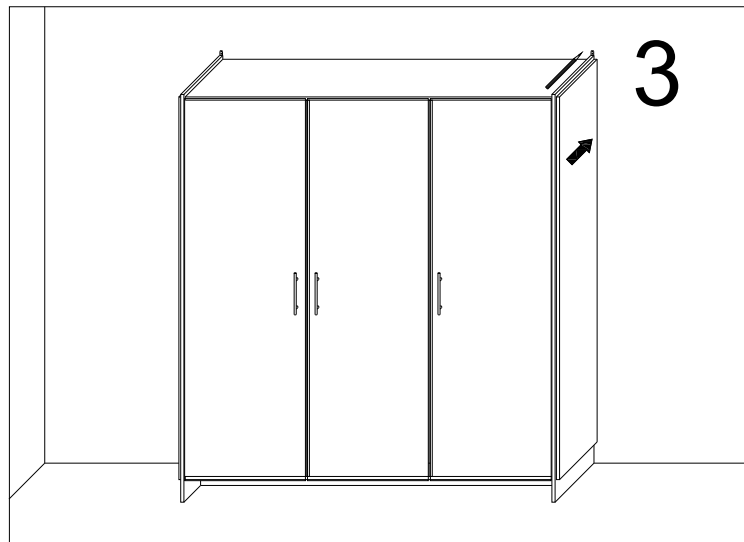
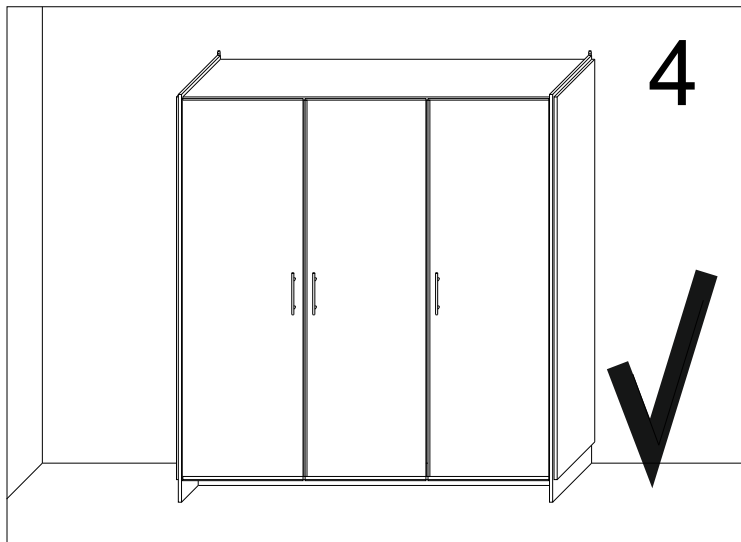
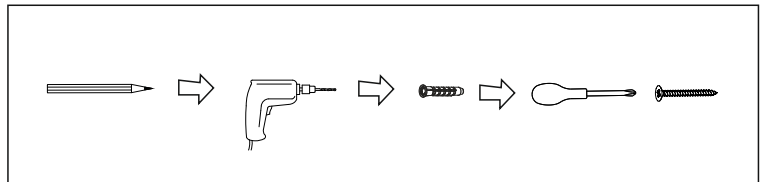
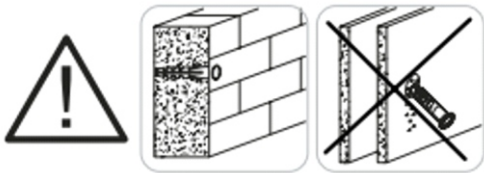
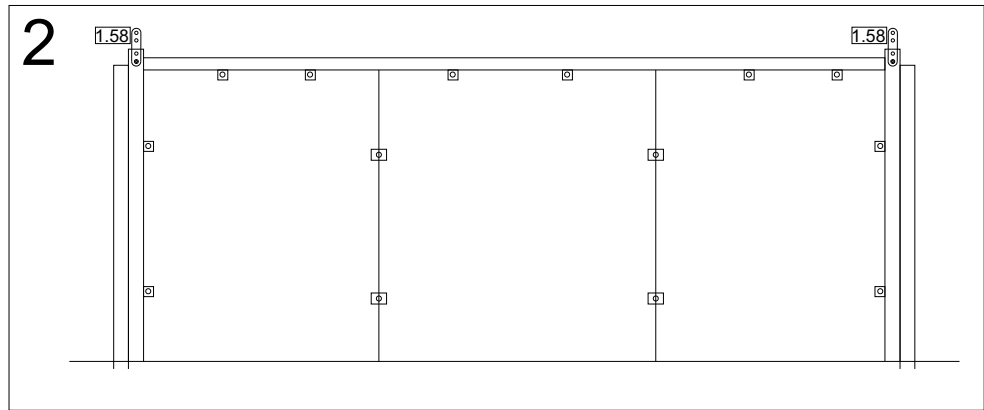
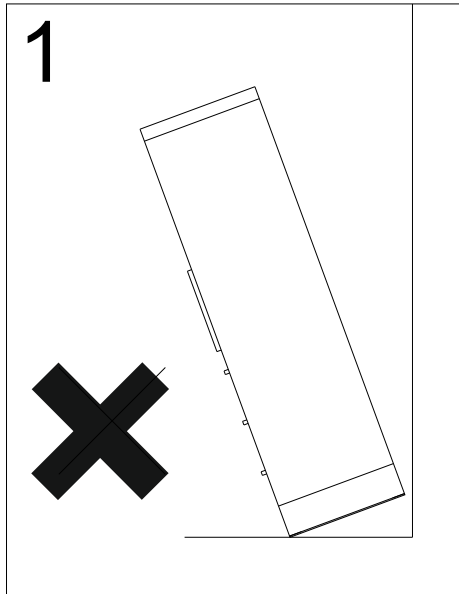

**Przy eksploatacji mebli zabrania się :**

- ustawiać meble w pobliżu grzewczych przyrządów i obok wilgotnych ścian, a także w pomieszczeniach ze względną wilgotnością więcej niż 70%
- temperatura nagrzewania elementów mebli nie może przekraczać +40 C
- w trakcie montażu i eksploatacji mebli stawać nogami na poziome panele i witryny
- stawać chemiczne środki czyszczące do sprzątania mebli
- nie należy narażać na kontakt z wodą

**Ostrzeżenie:**

- zawsze przymocuj mebel do ściany za pomocą ograniczników
- do montażu na ścianie użyj kołków odpowiednich do materiału z którego wykonana jest ściana, jeśli nie masz pewności skontaktuj się ze specjalistą. Ostatecznie za elementy łączne odpowiedzialny jest instalator.
- należy przestrzegać maksymalnych obciążeń