

# Moris/Mopic/Mopис

**Chest of 2W2D**  
**Komoda 2W2D**  
**Комод 2В2Д**





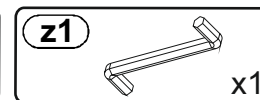
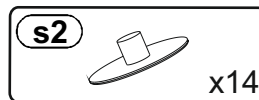
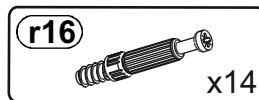
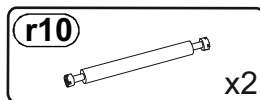
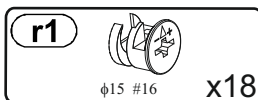
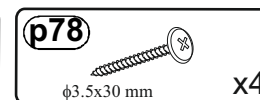
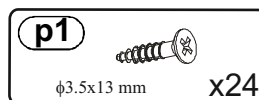
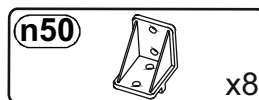
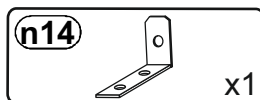
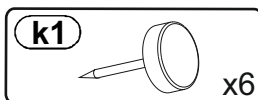
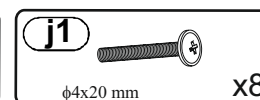
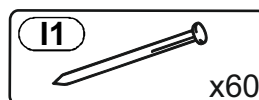
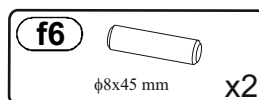
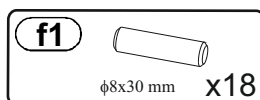
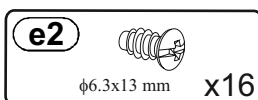
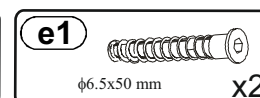
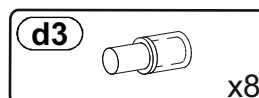
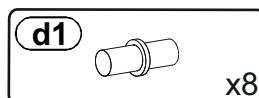
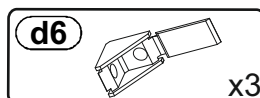
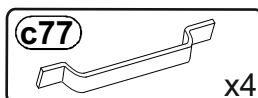
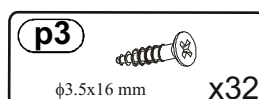
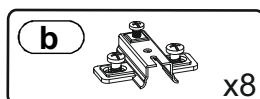
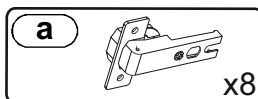
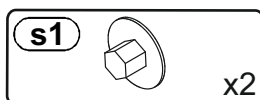
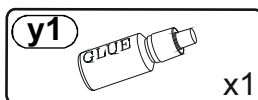
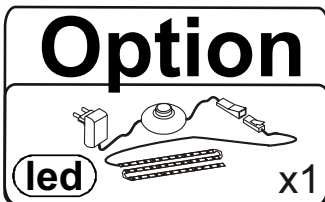
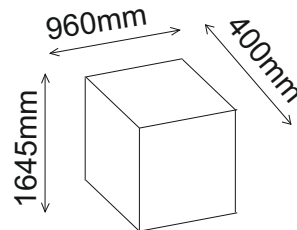
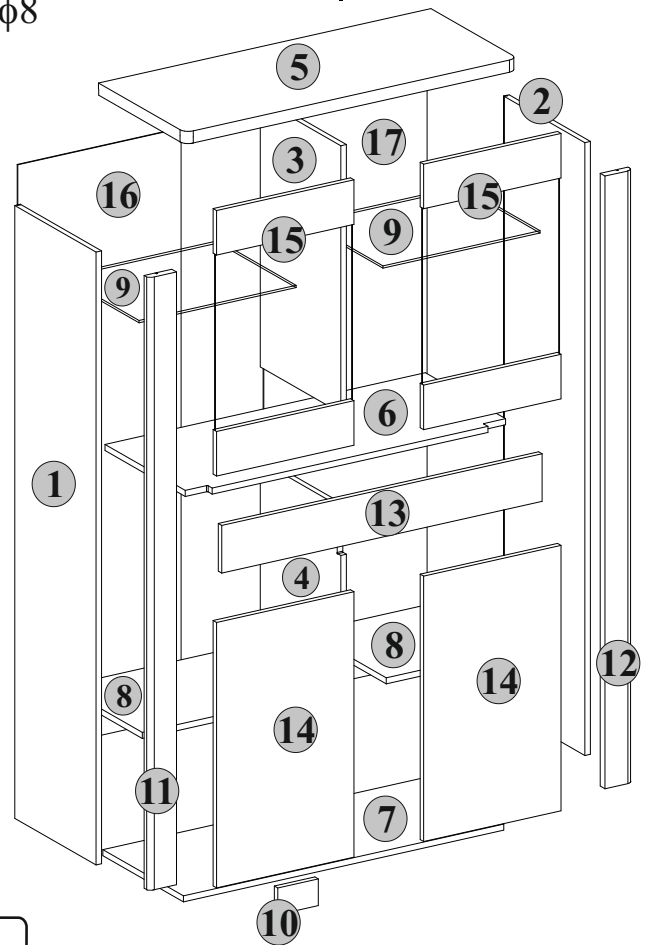
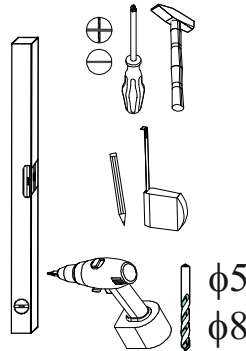
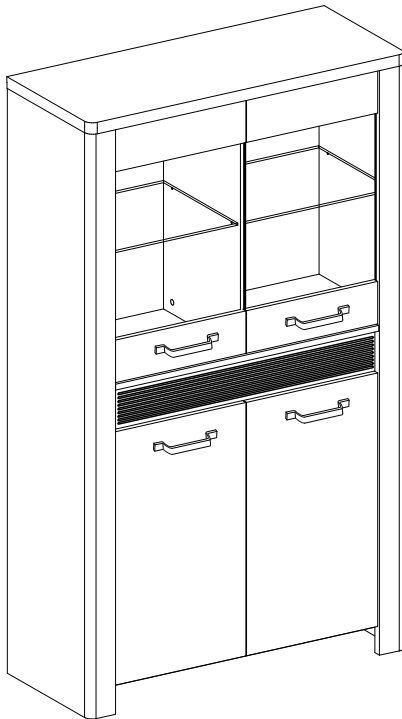

number	Measurements	Pcs.
1	1609x375	1
2	1609x375	1
3	702x372	1
4	805x372	1
5	960x400	1
6	926x392	1
7	926x372	1
8	454x370	2
9	454x360	2
10	70x116	1
11,12	1609x80	2

13	926x125	1
14	396x696	2
15	696x396	2
16	1547x472	1
17	1547x472	1

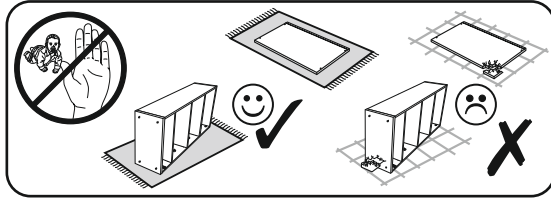

# I

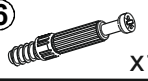

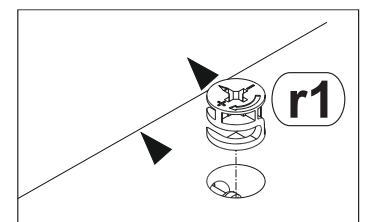
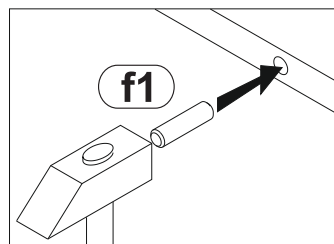
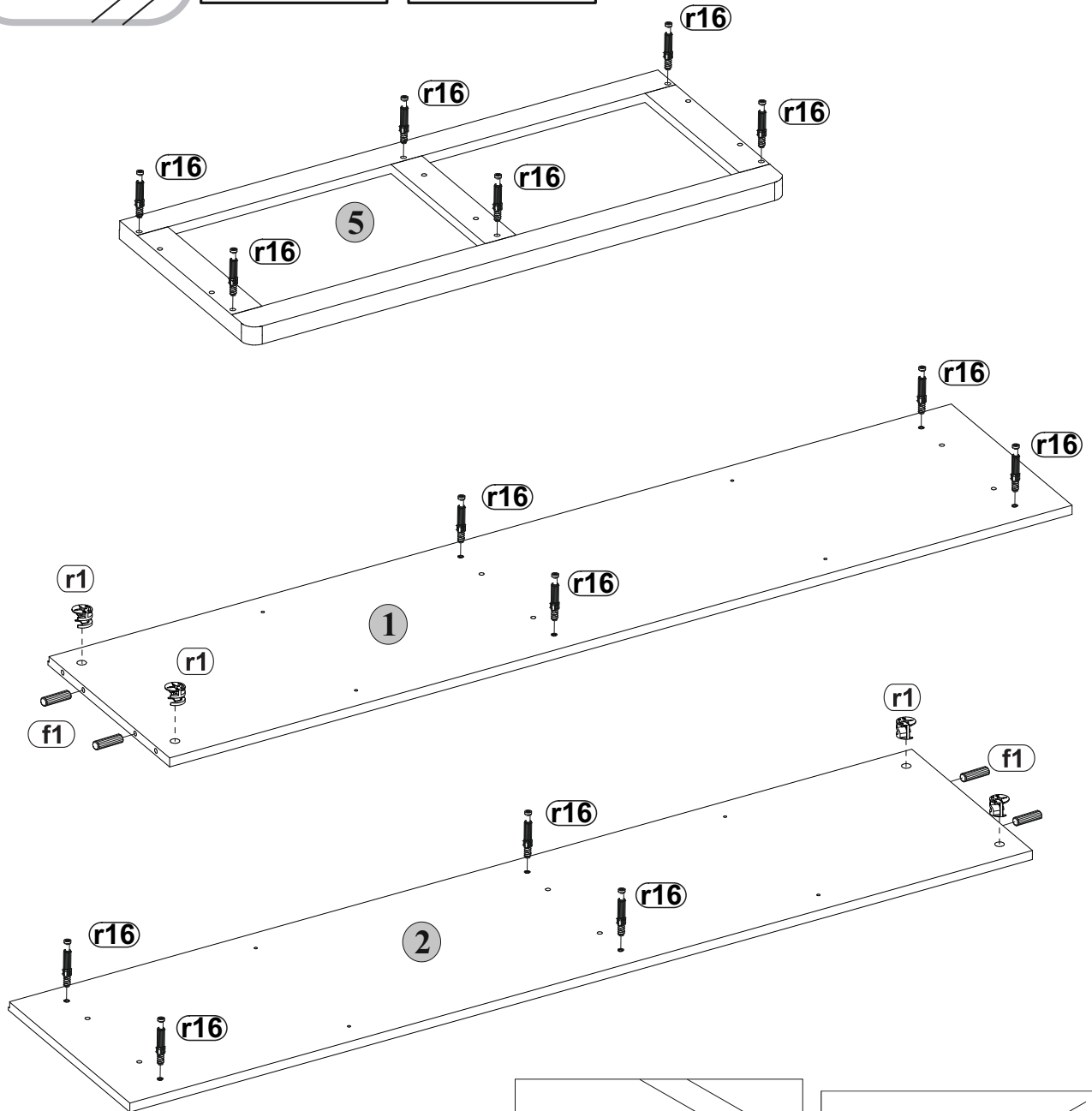
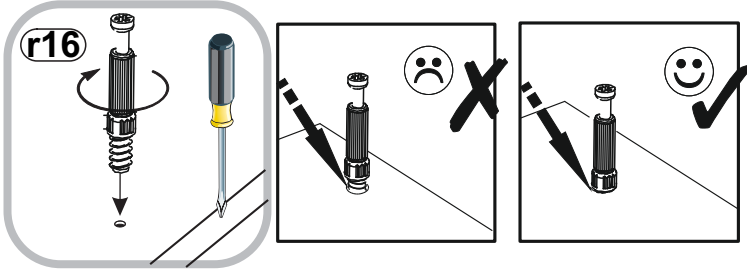

- r1**   $\phi 15 \#16$  x4
- r16**  x14
- f1**   $\phi 8 \times 30$  mm x4

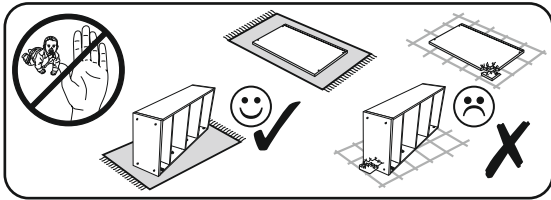

# 2

**2**



- r1**   $\phi 15 \#16$  x14
- f1**   $\phi 8 \times 30$  mm x12

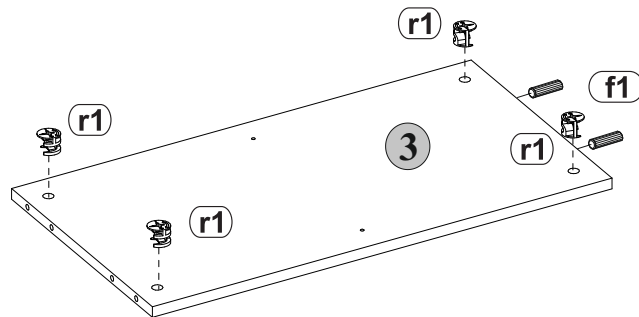
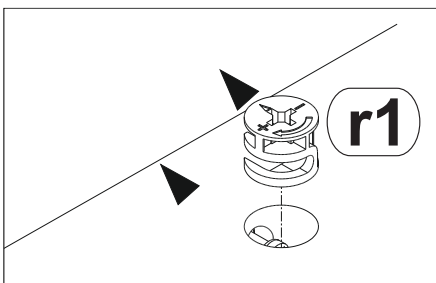
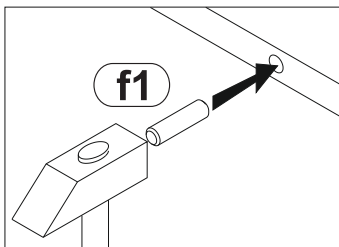
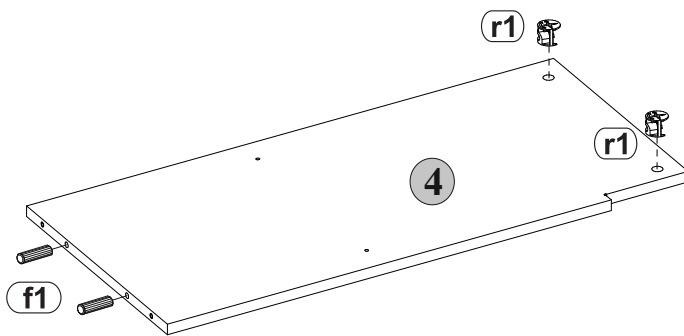
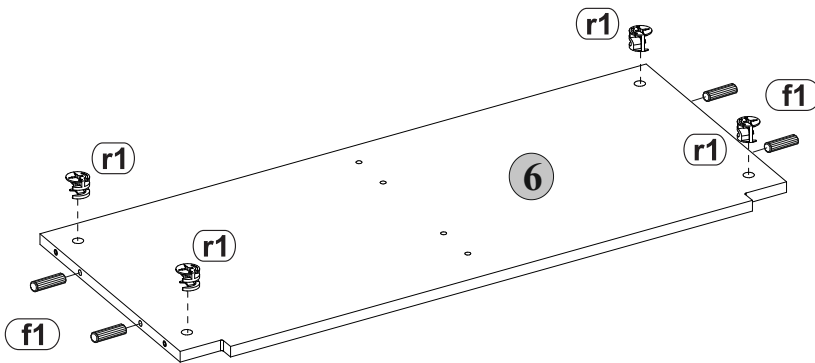
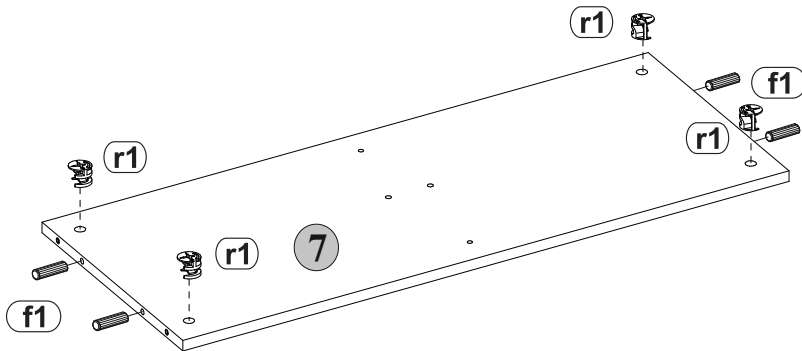

**3**

3

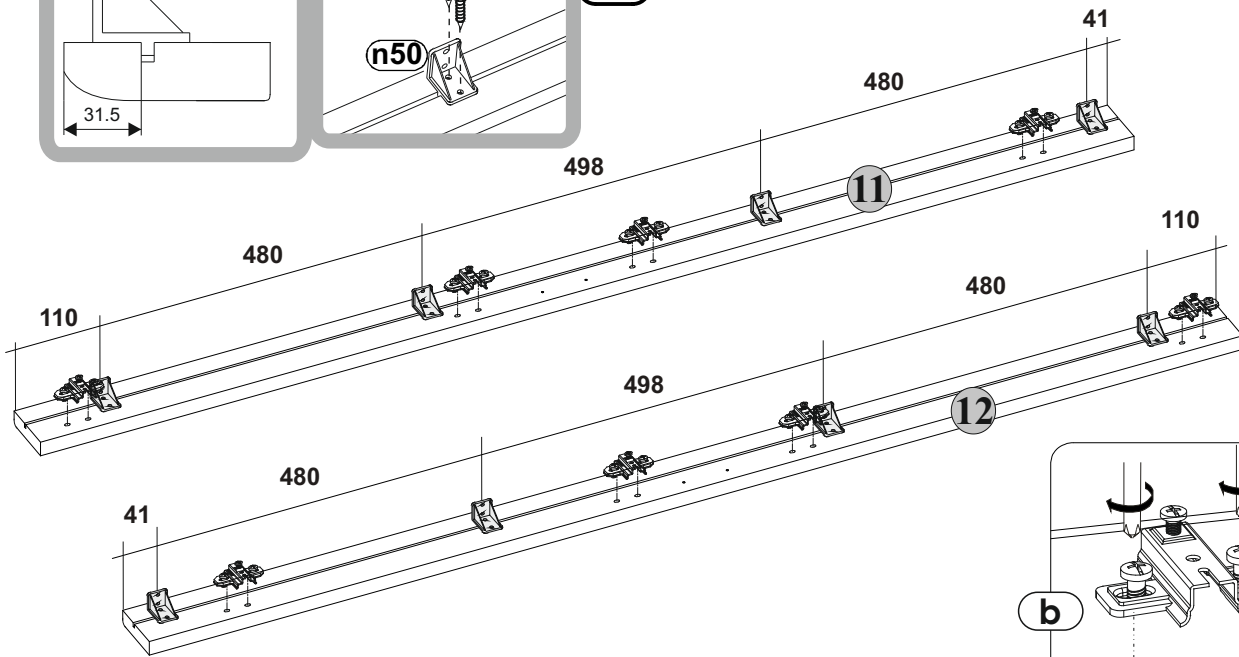
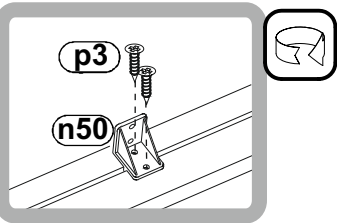
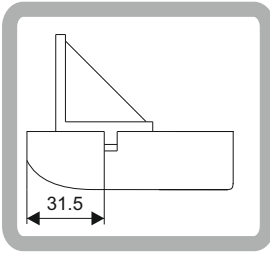
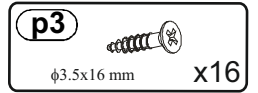
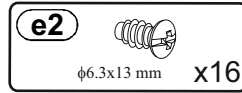
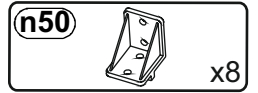
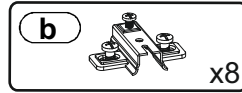
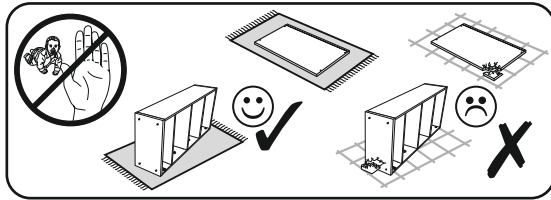

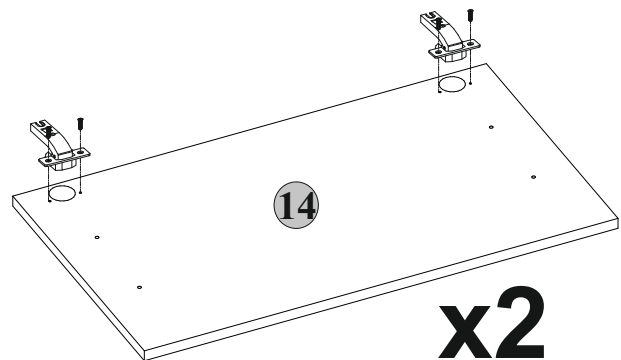
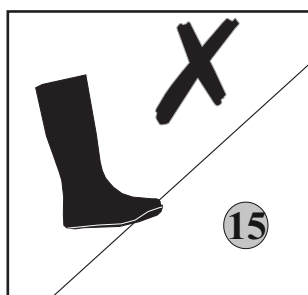
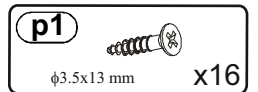
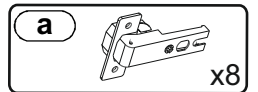
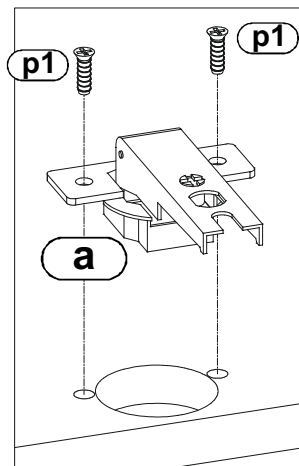
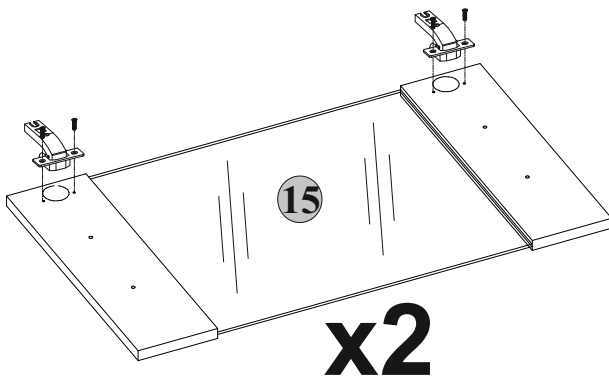

4

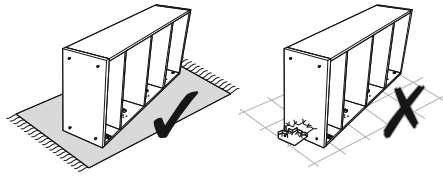

4

5



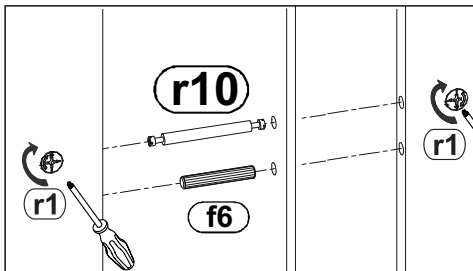
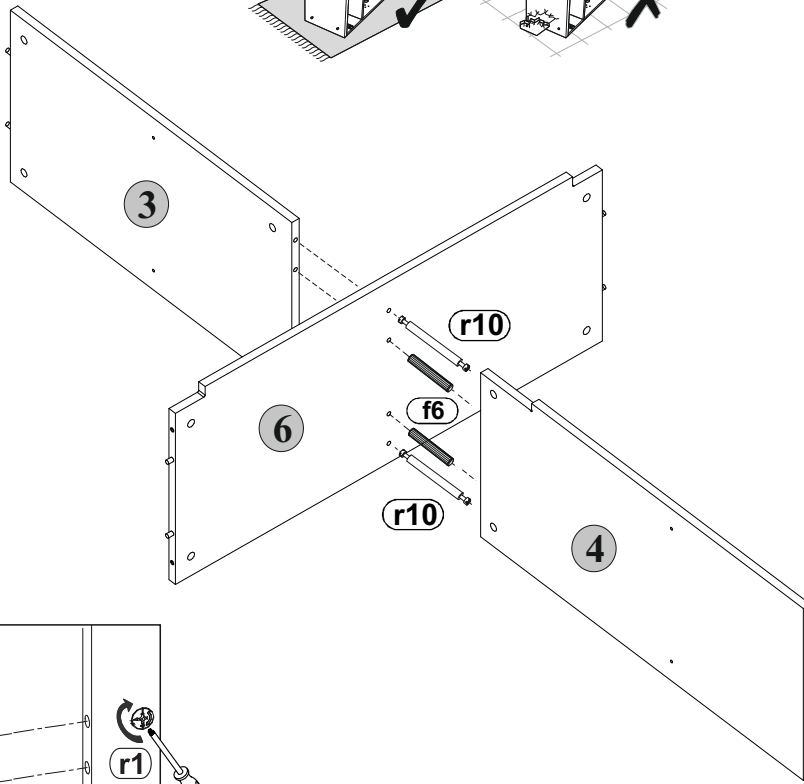

- r10**  x2
- f6**   $\phi 8 \times 45$  mm x2

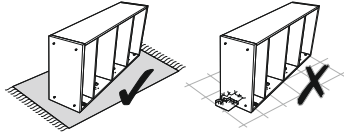

6

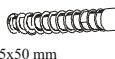

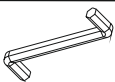
- e1**   $\phi 6.5 \times 50$  mm x2
- s1**  x2
- z1**  x1

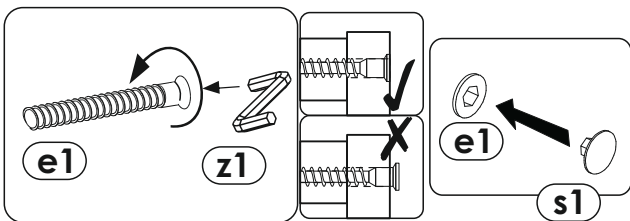
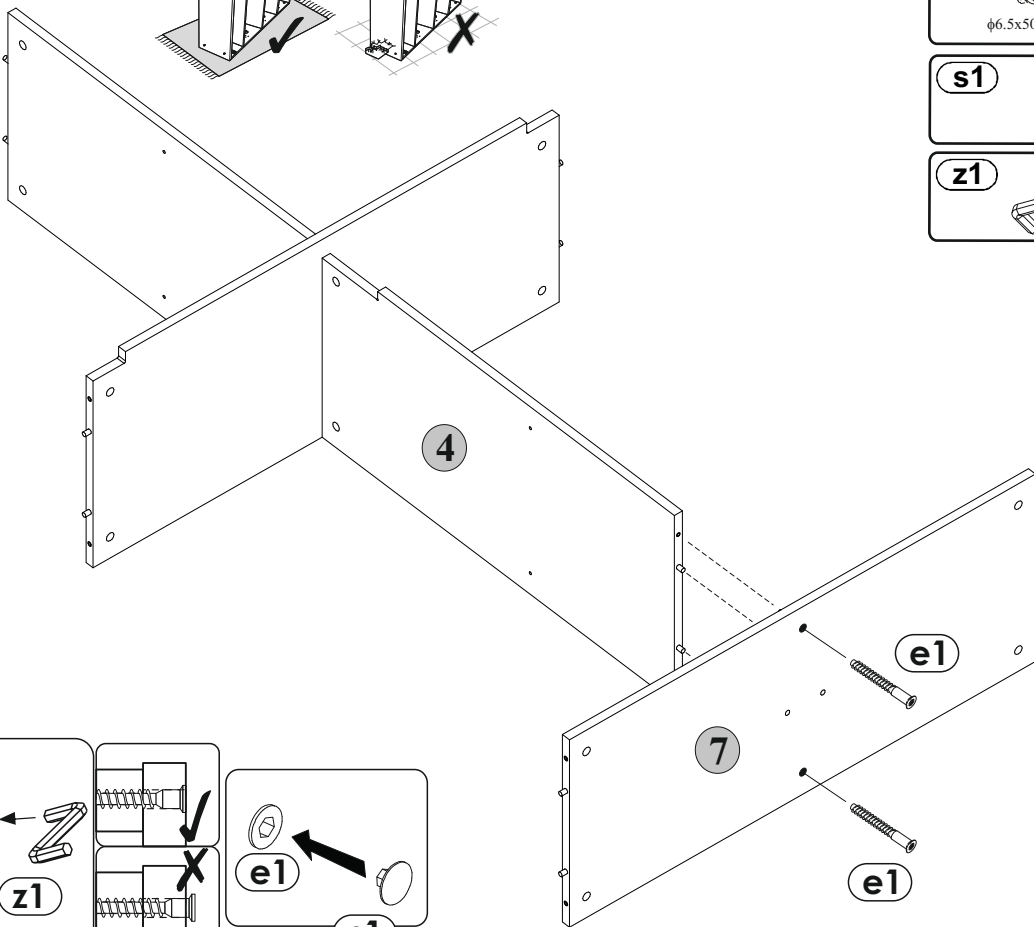

5

7

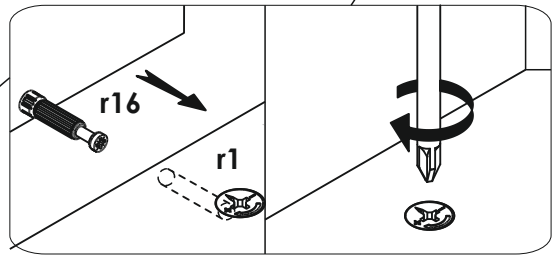
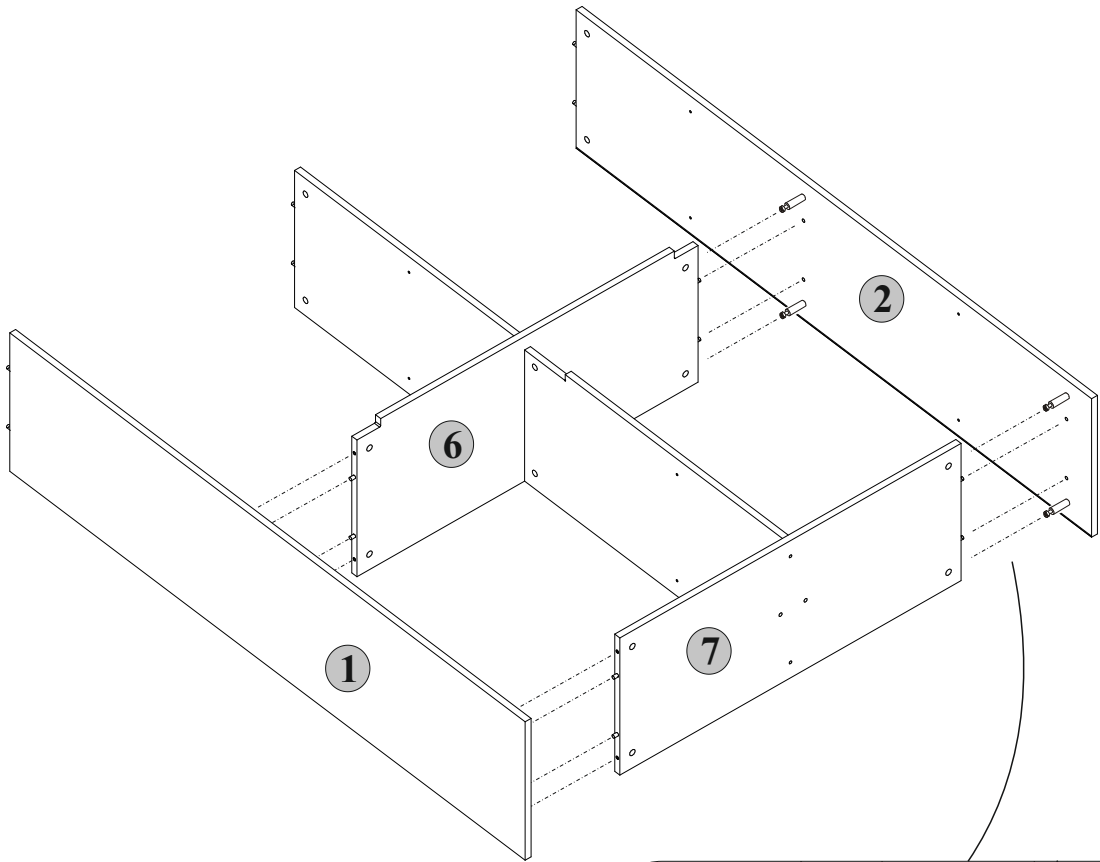

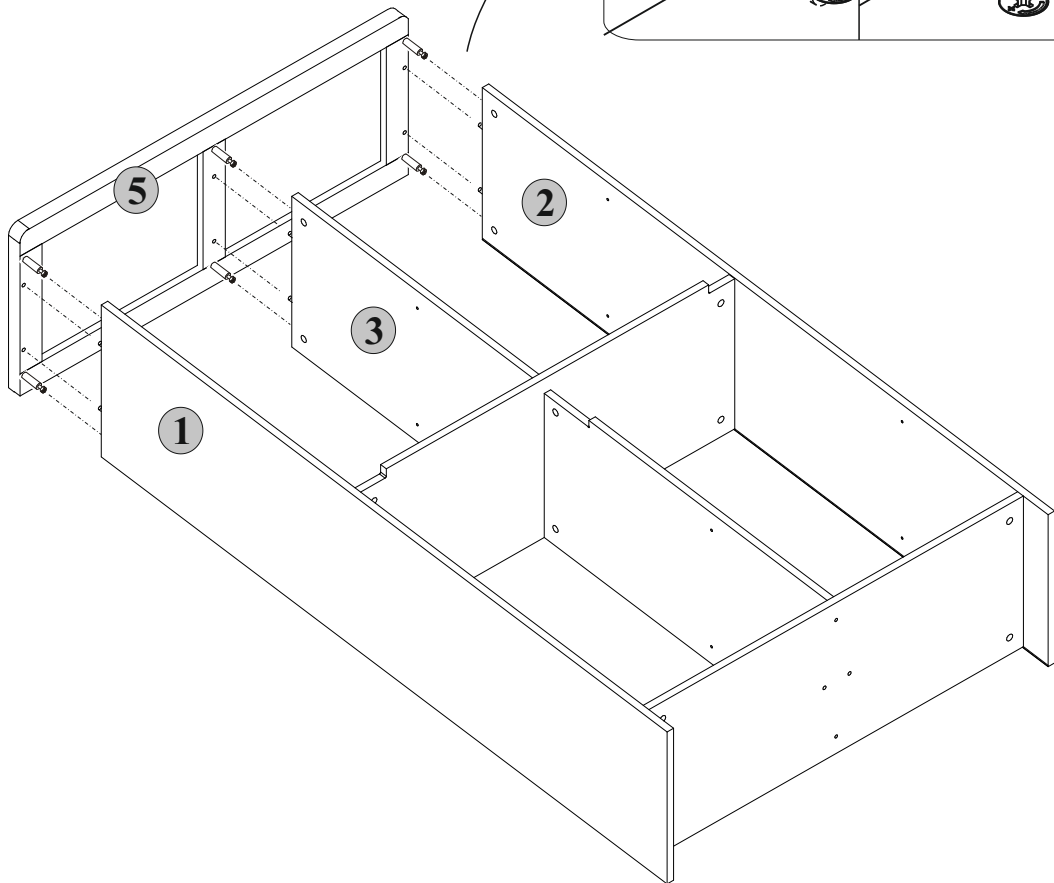

8



6

9

- p3**   $\phi 3.5 \times 16$  mm x16
- f1**   $\phi 8 \times 30$  mm x2

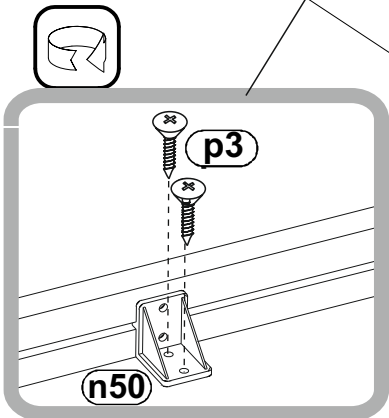
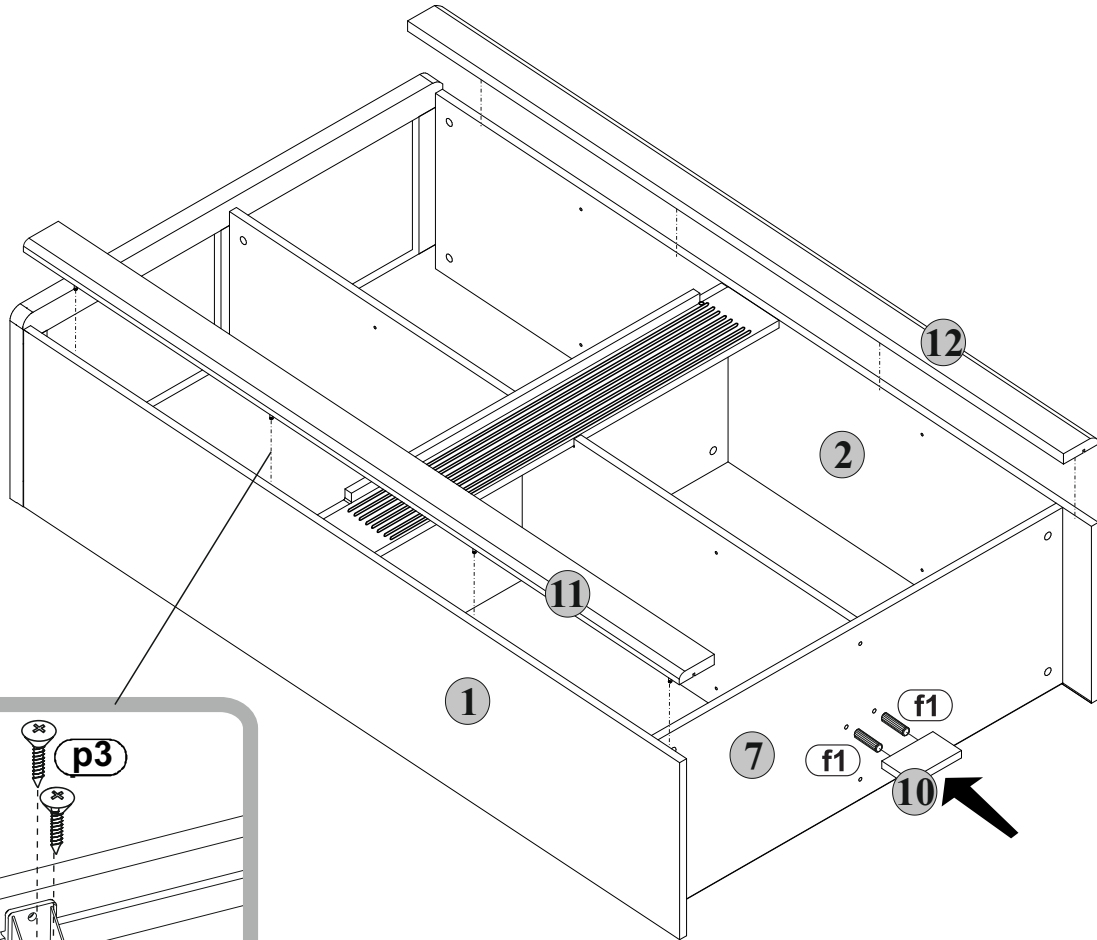
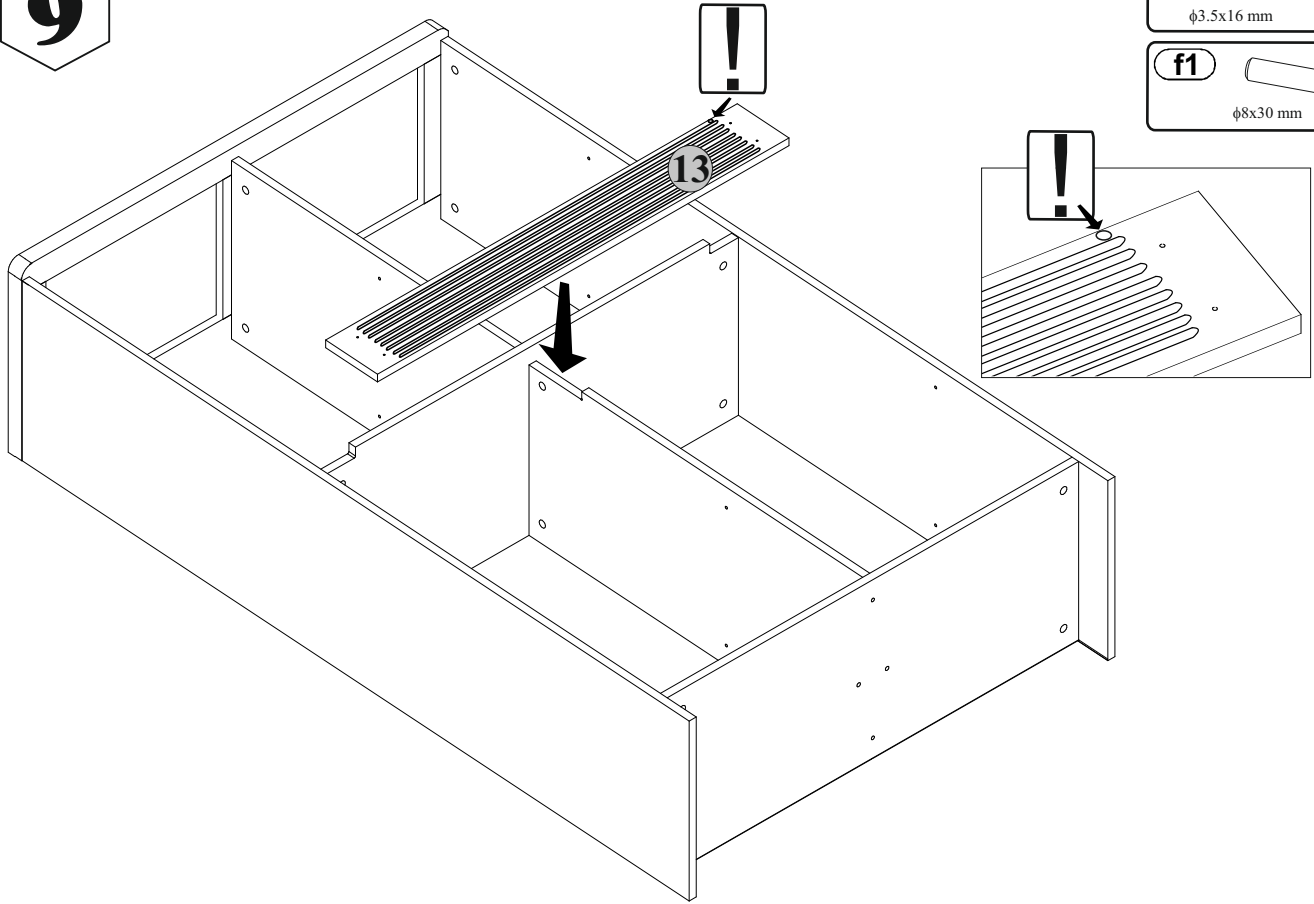

7

**10**

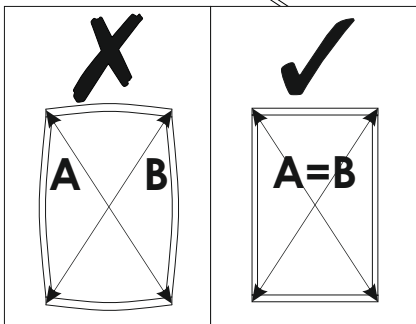
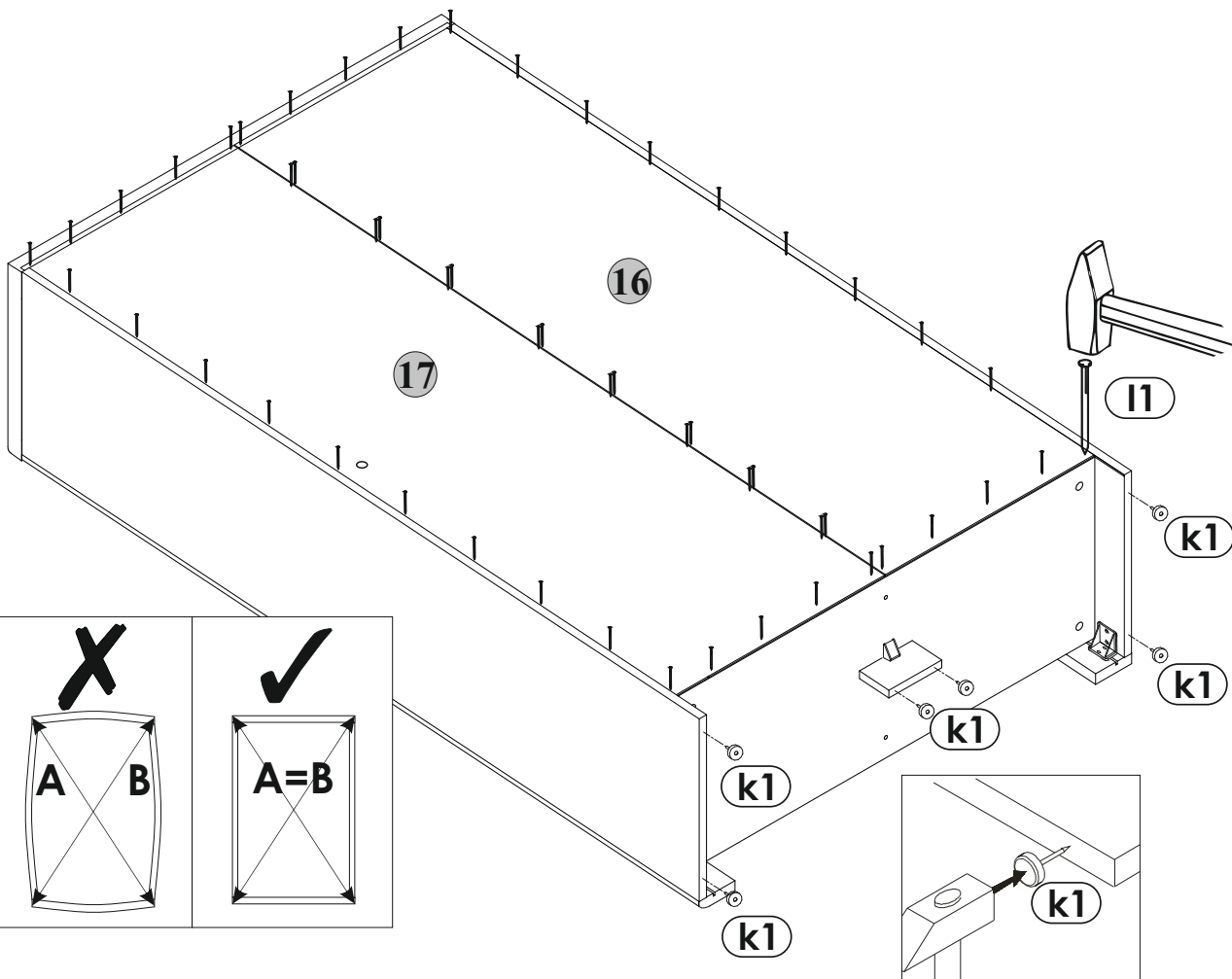
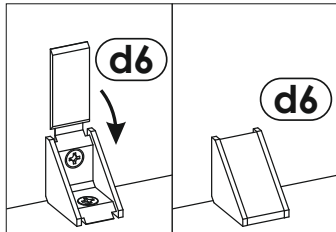
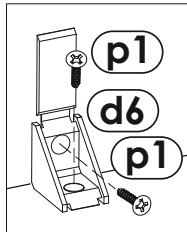
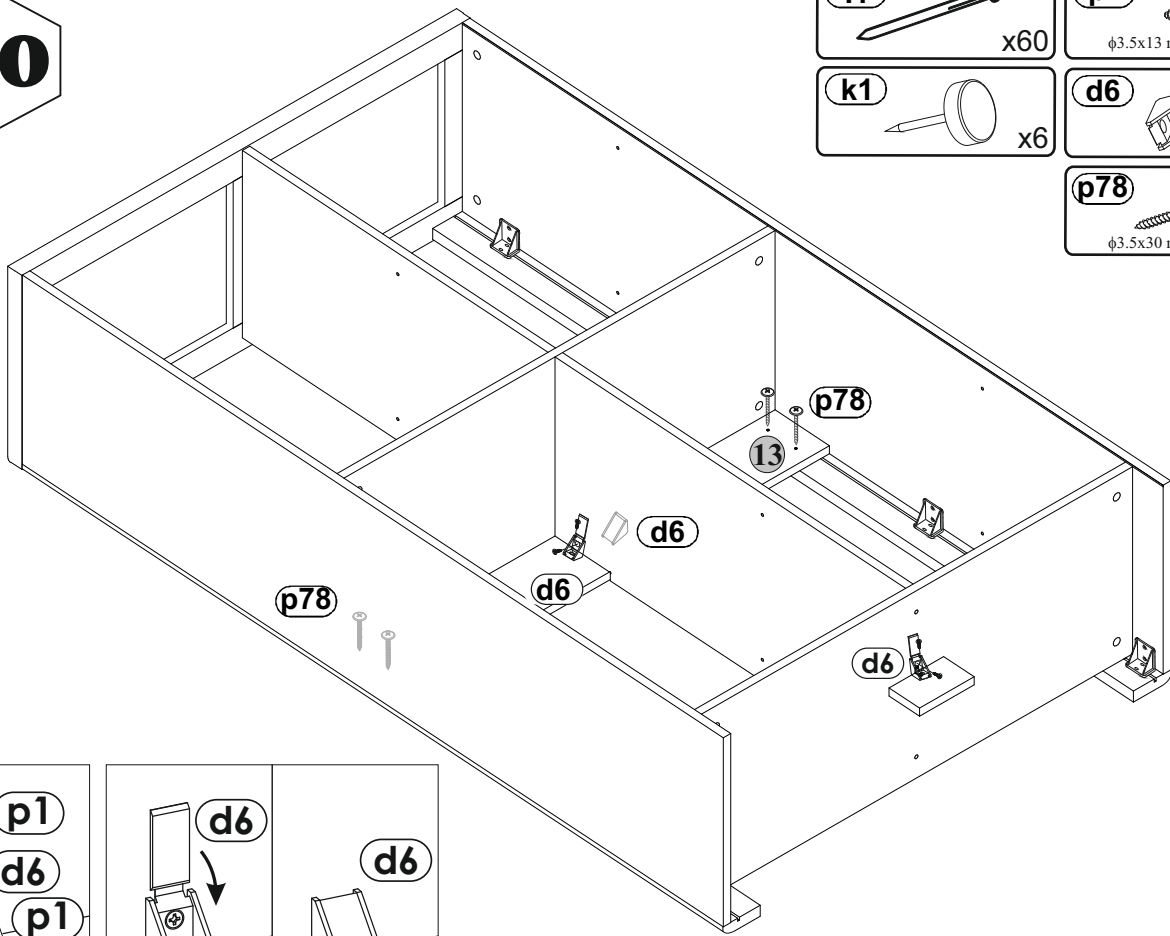
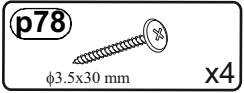
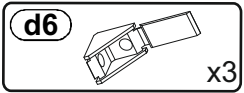
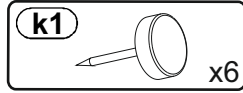
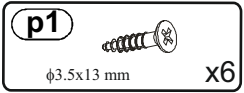

**8**



**11**

**c77**  
x4

**j1**  
φ4x25 mm  
x8

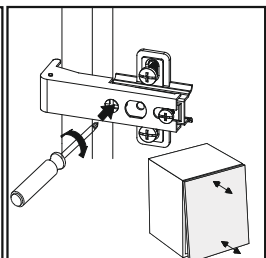
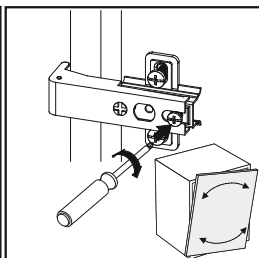
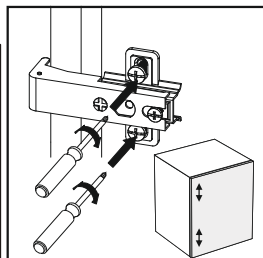
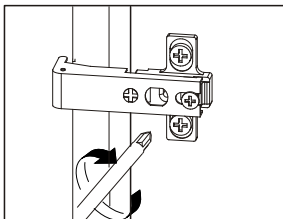
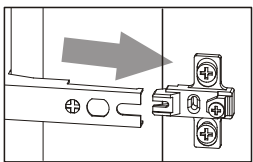
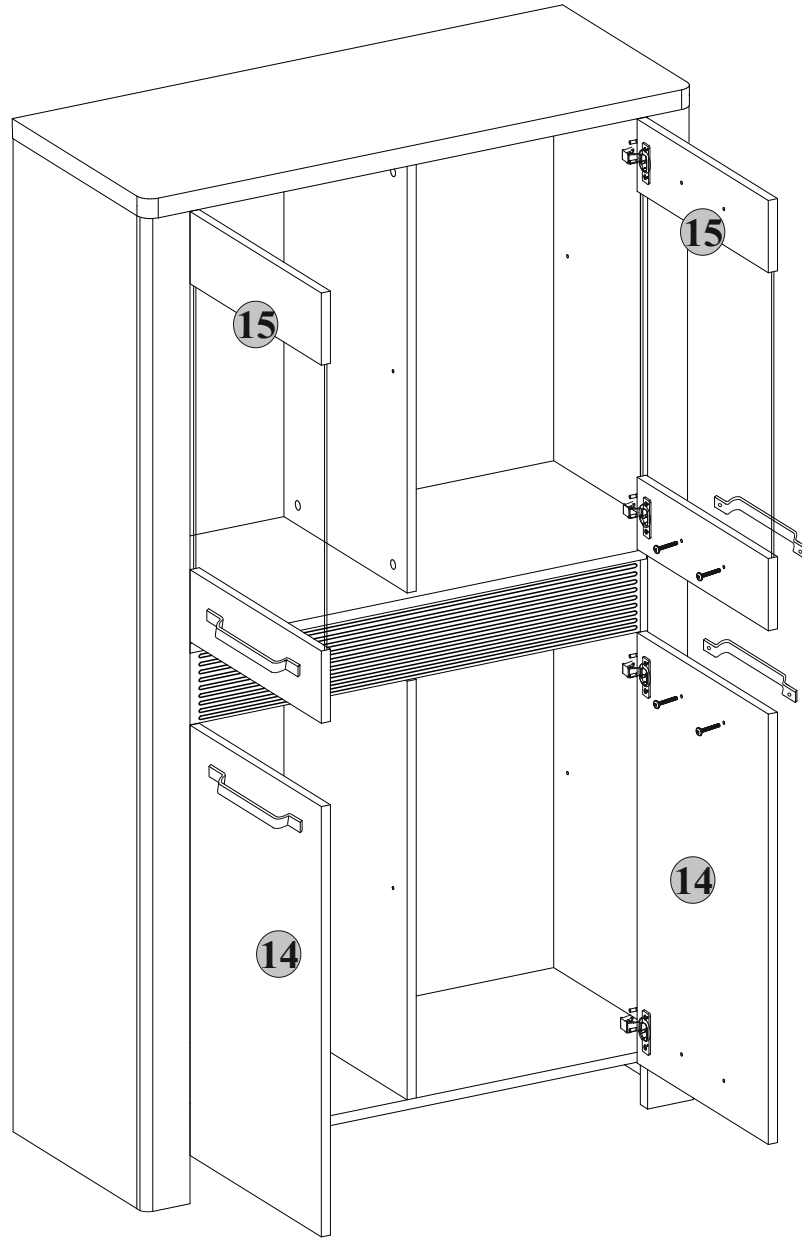
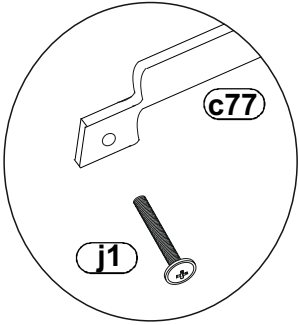
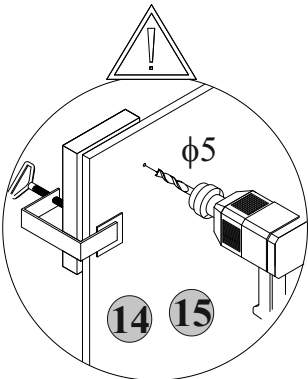

**9**

**12**

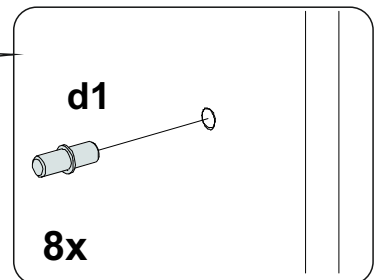
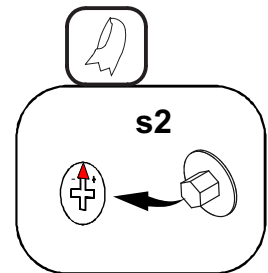
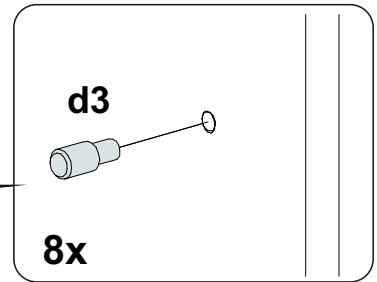
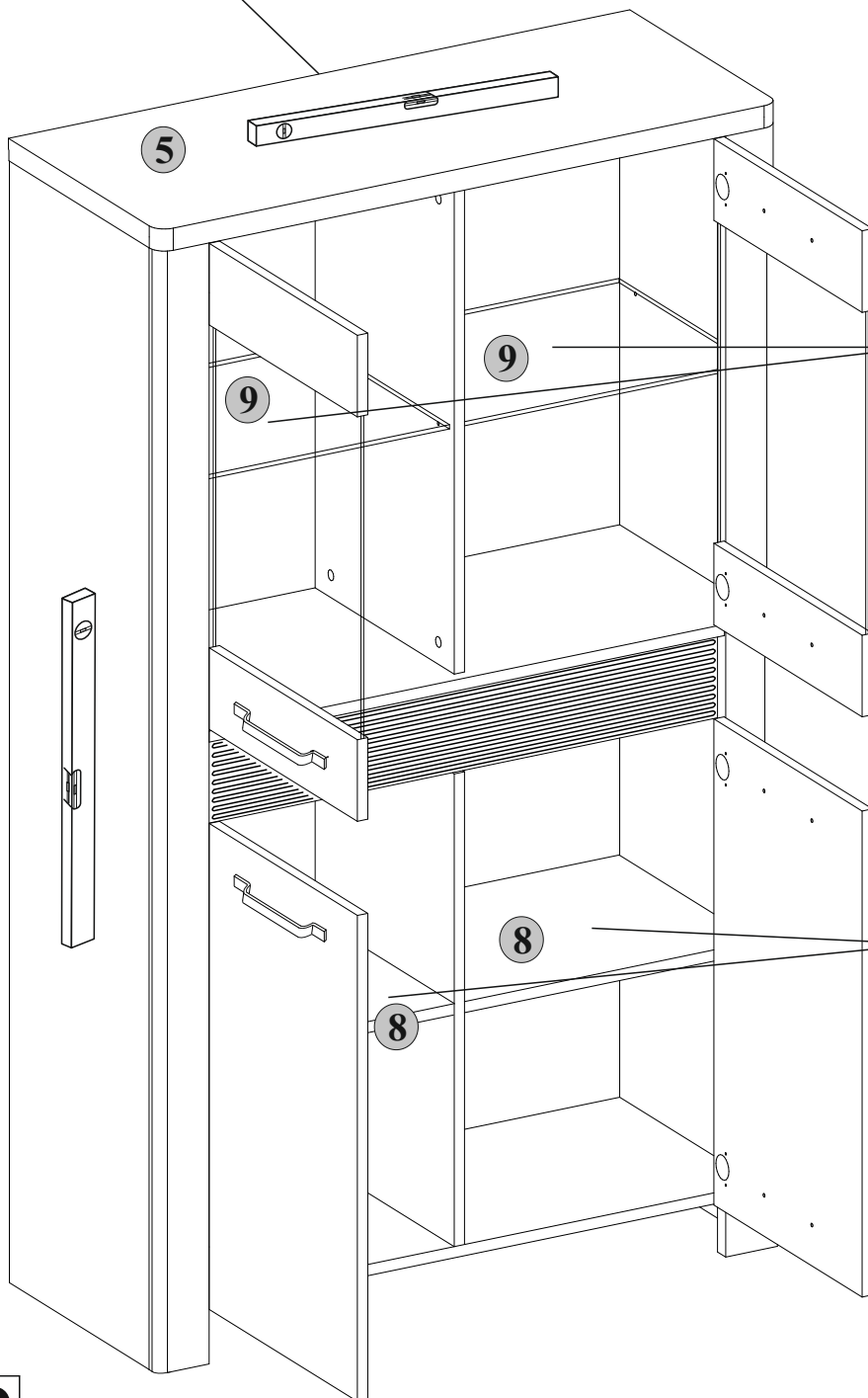
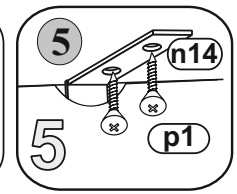
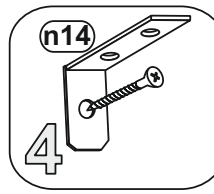
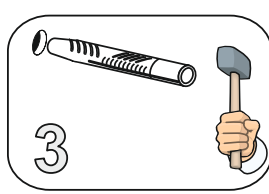
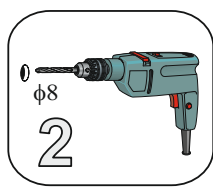
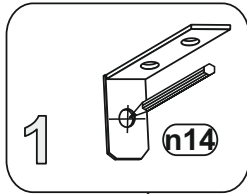
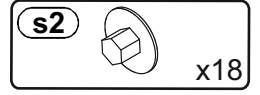
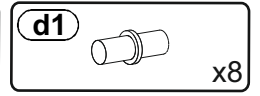
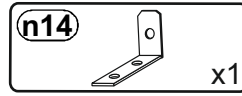
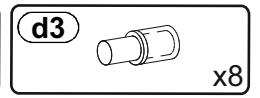
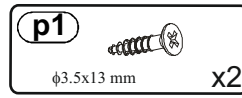

**10**

**OPTION**

**Option**

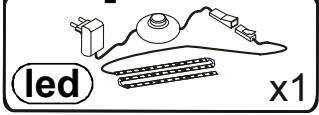

led x1

