

Moris/Mopic/Mopis

Wardrobe 4D Szafa 4D Шафа 4Д







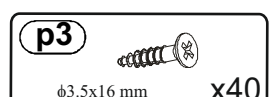
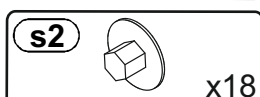
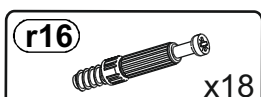
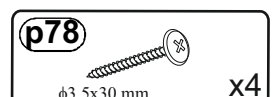
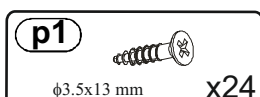
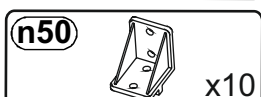
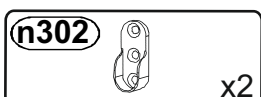
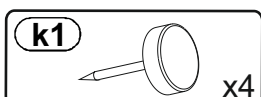
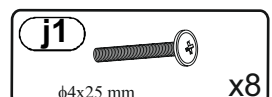
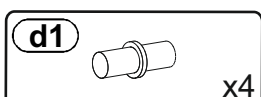
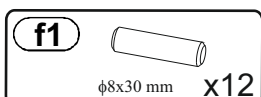
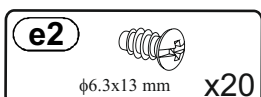
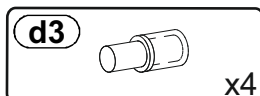
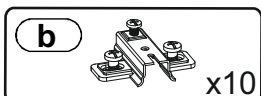
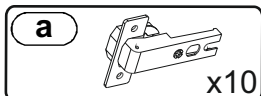
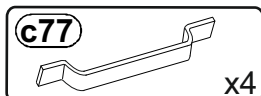
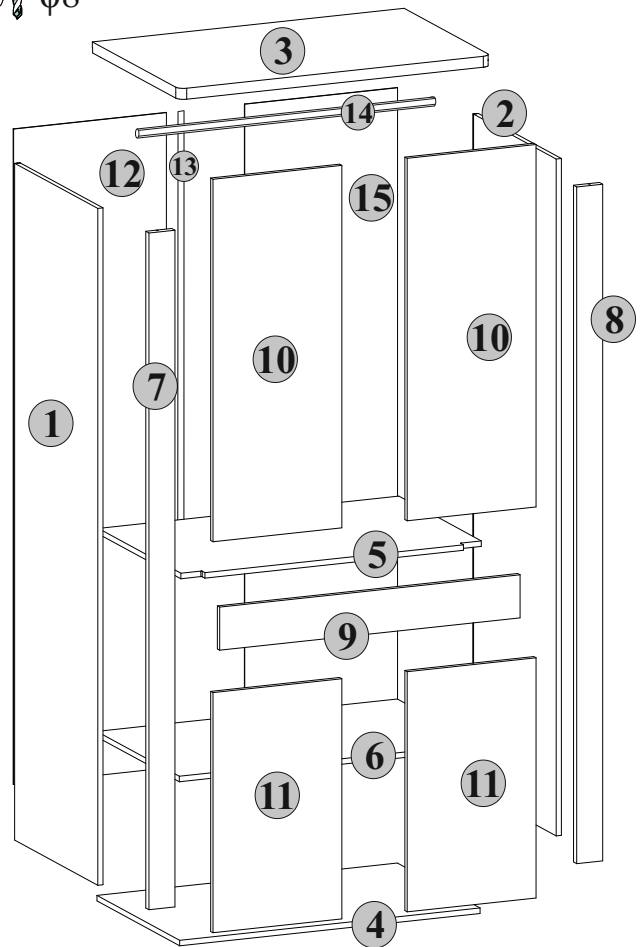
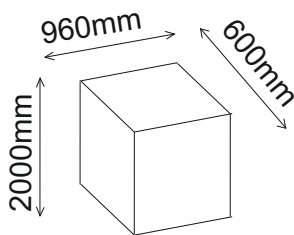
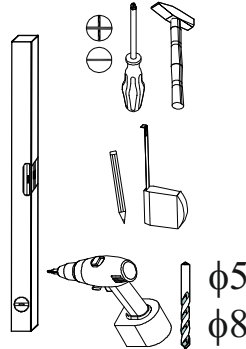

number	Measurements	Pcs.
1	1964x575	1
2	1964x575	1
3	960x600	1
4	926x572	1
5	926x592	1
6	926x571	1
7	1964x80	1
8	1964x80	1
9	926x125	1
10	396x1051	2
11	396x696	2

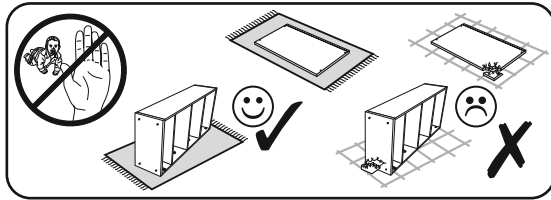
12	1902x471	2
13	1878x	1
14	903x	1
15	1902x471	1



I



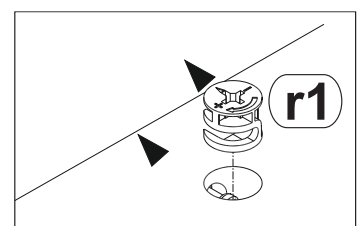
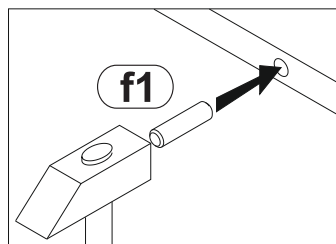
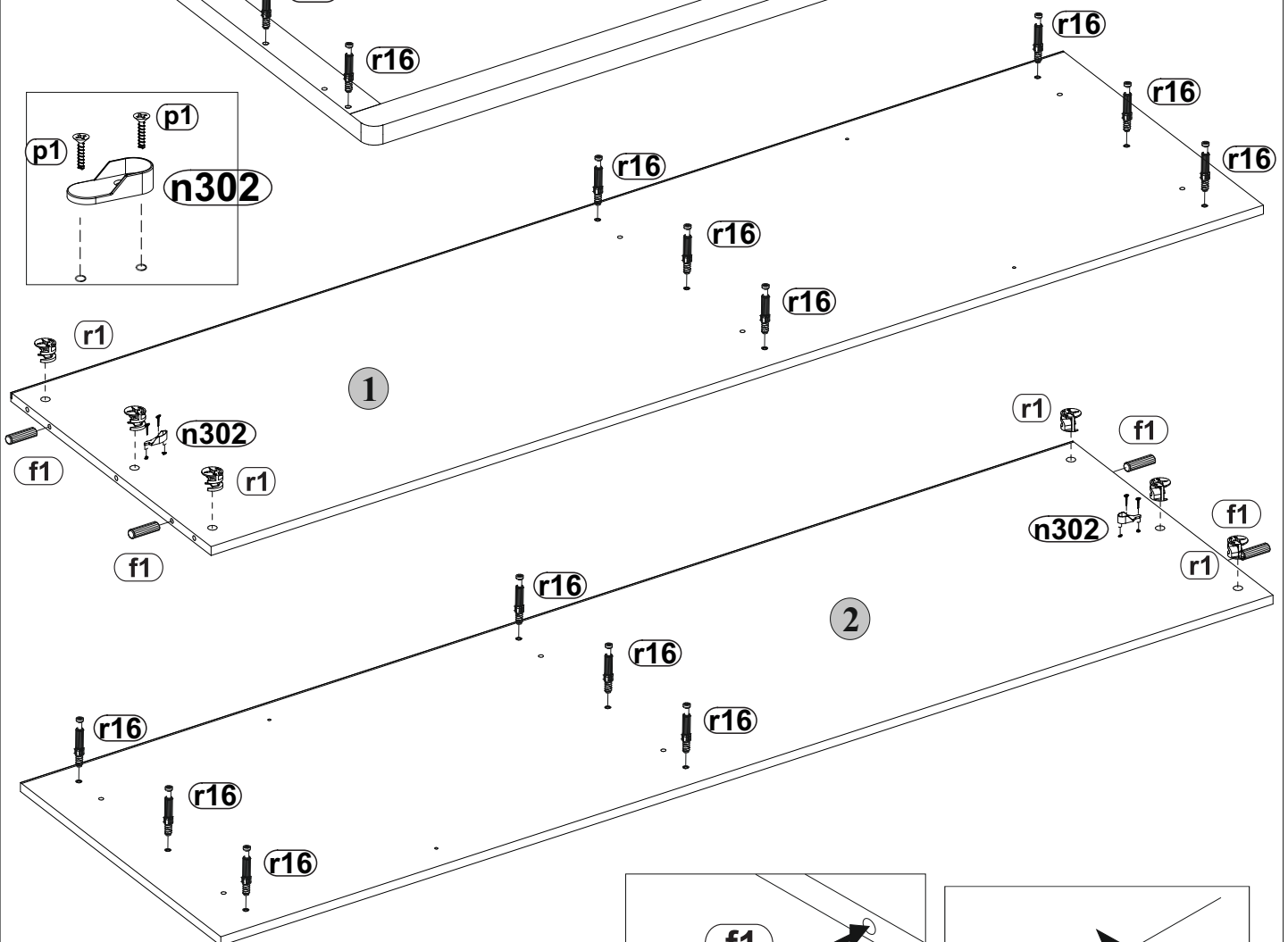
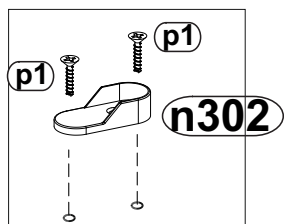
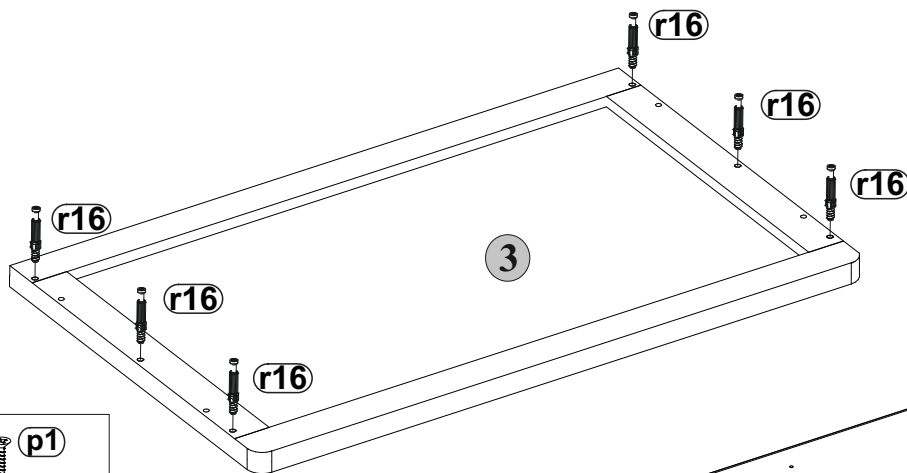
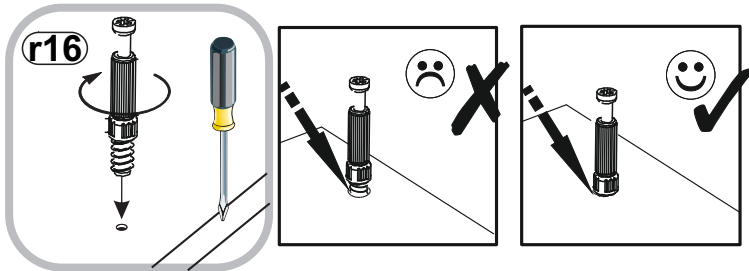

- r1**  $\phi 15 \#16$ x6
- r16**  x18
- f1**  $\phi 8 \times 30$ mm x4
- p1**  $\phi 3.5 \times 13$ mm x4
- n302**  x2

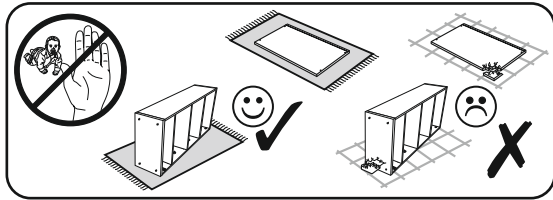

2

2





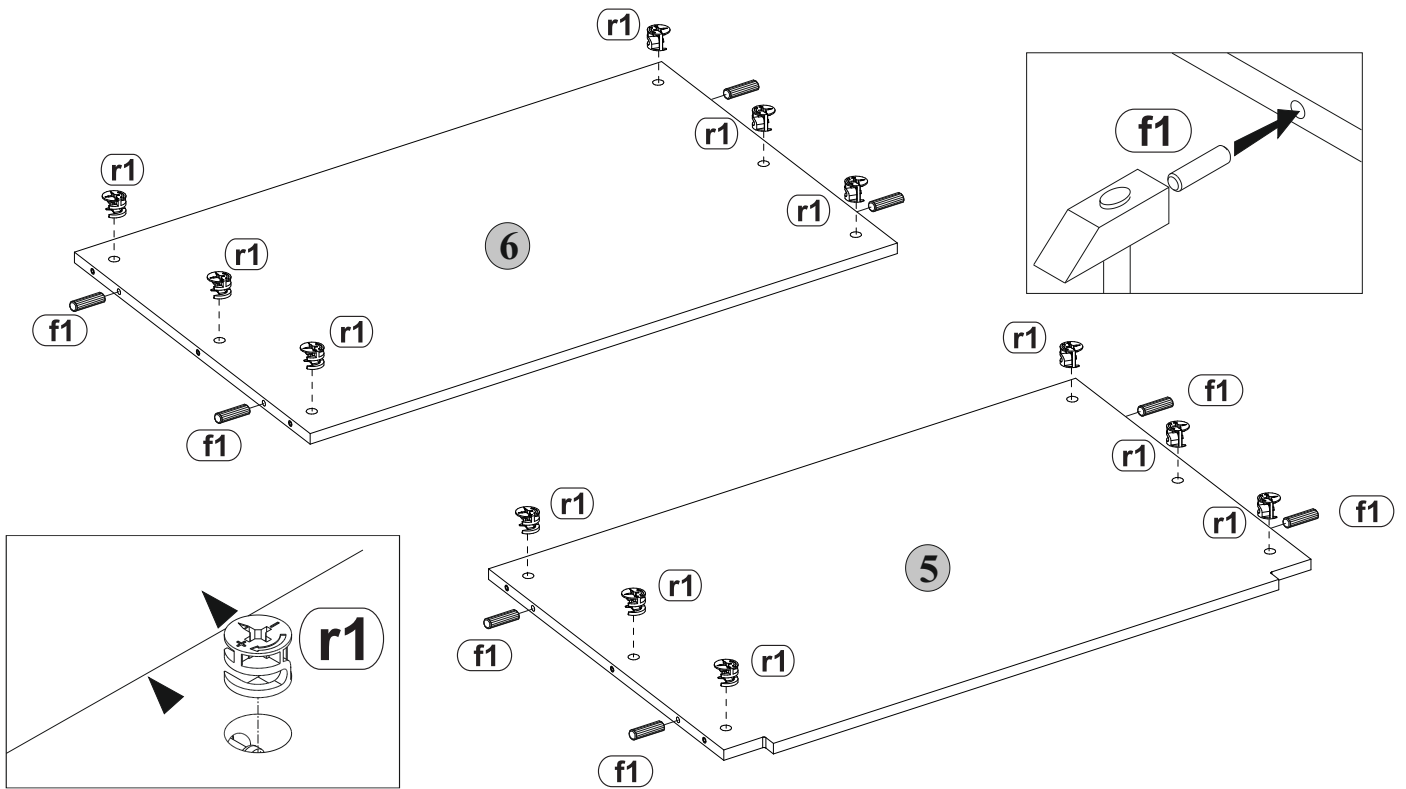

- r1**  $\phi 15 \#16$ x12
- f1**  $\phi 8 \times 30$ mm x8

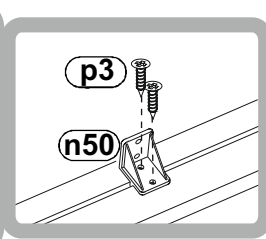
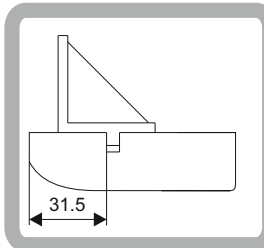

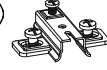
3



- b**  x10
- n50**  x10
- e2**  $\phi 6.3 \times 13$ mm x20
- p3**  $\phi 3.5 \times 16$ mm x20

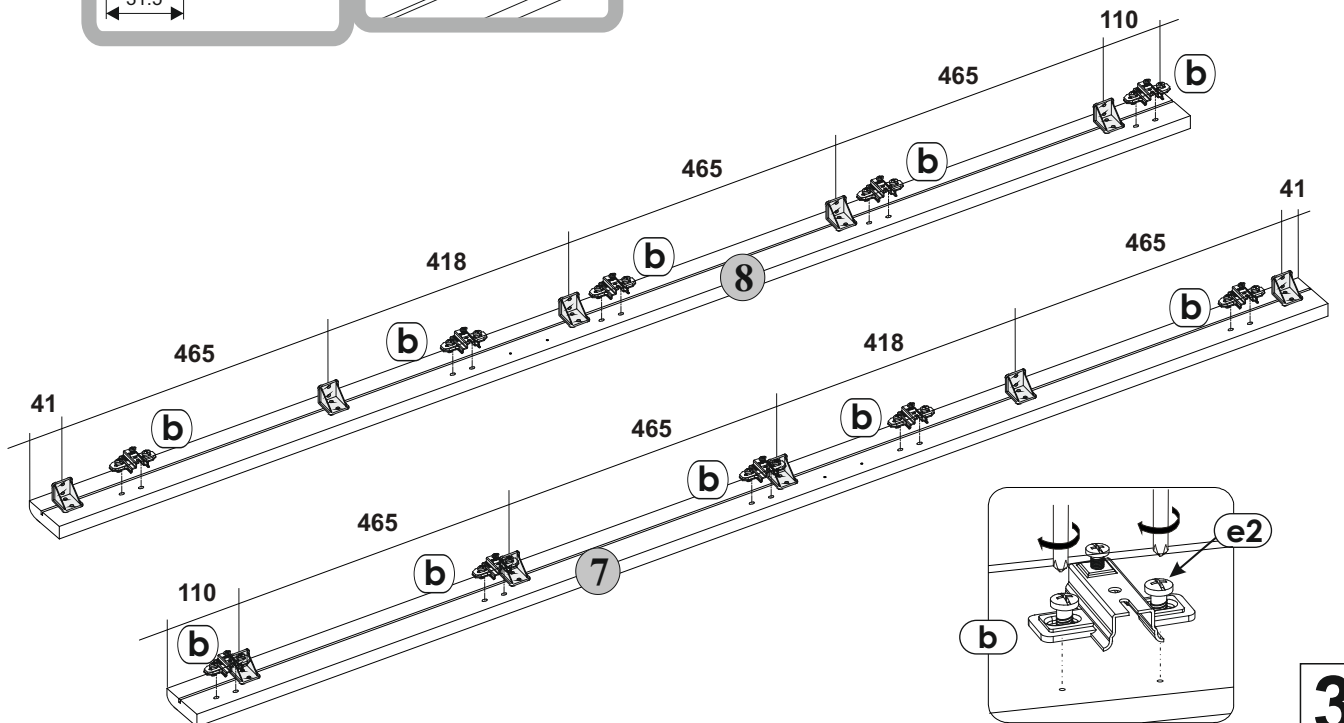

3

4

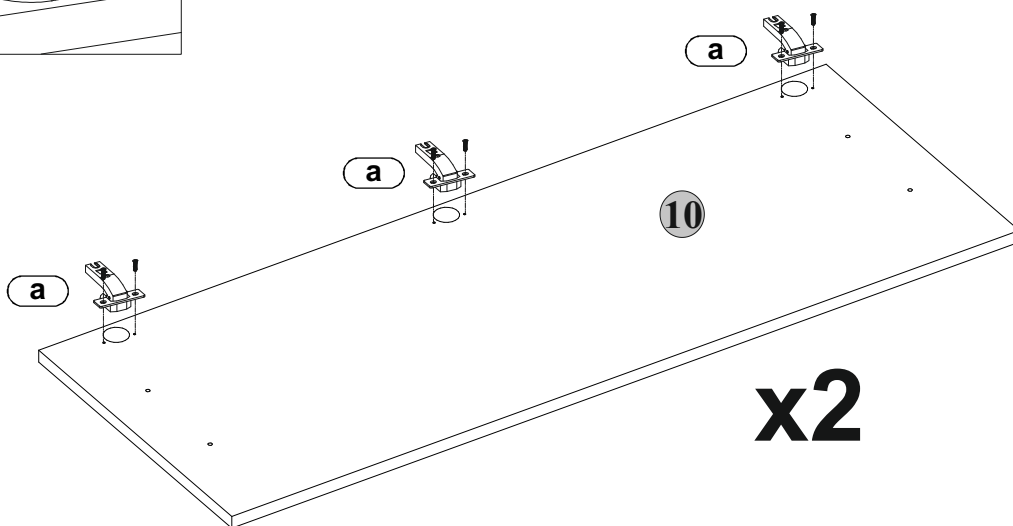
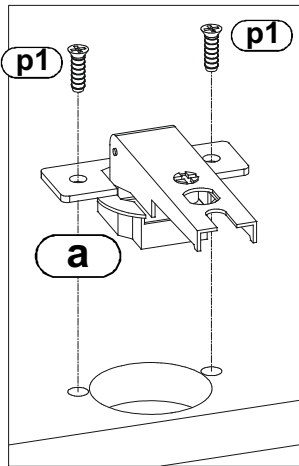
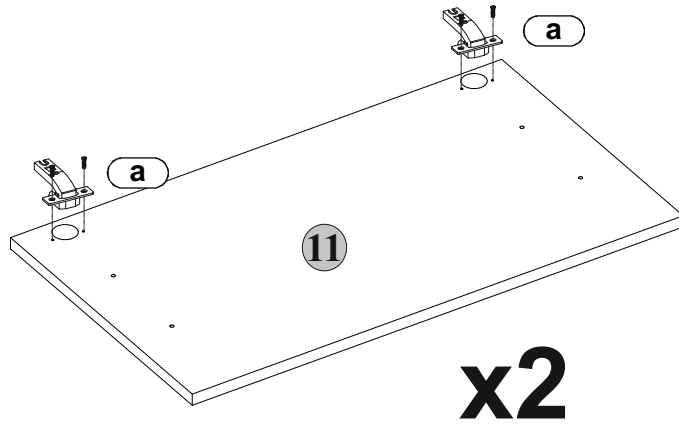
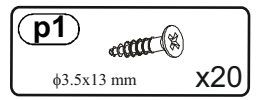
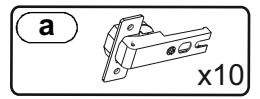
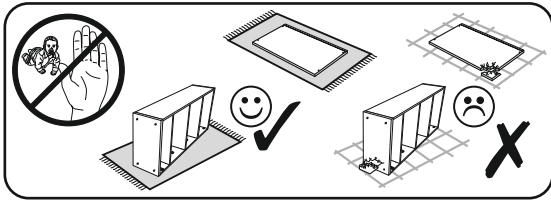

4

5

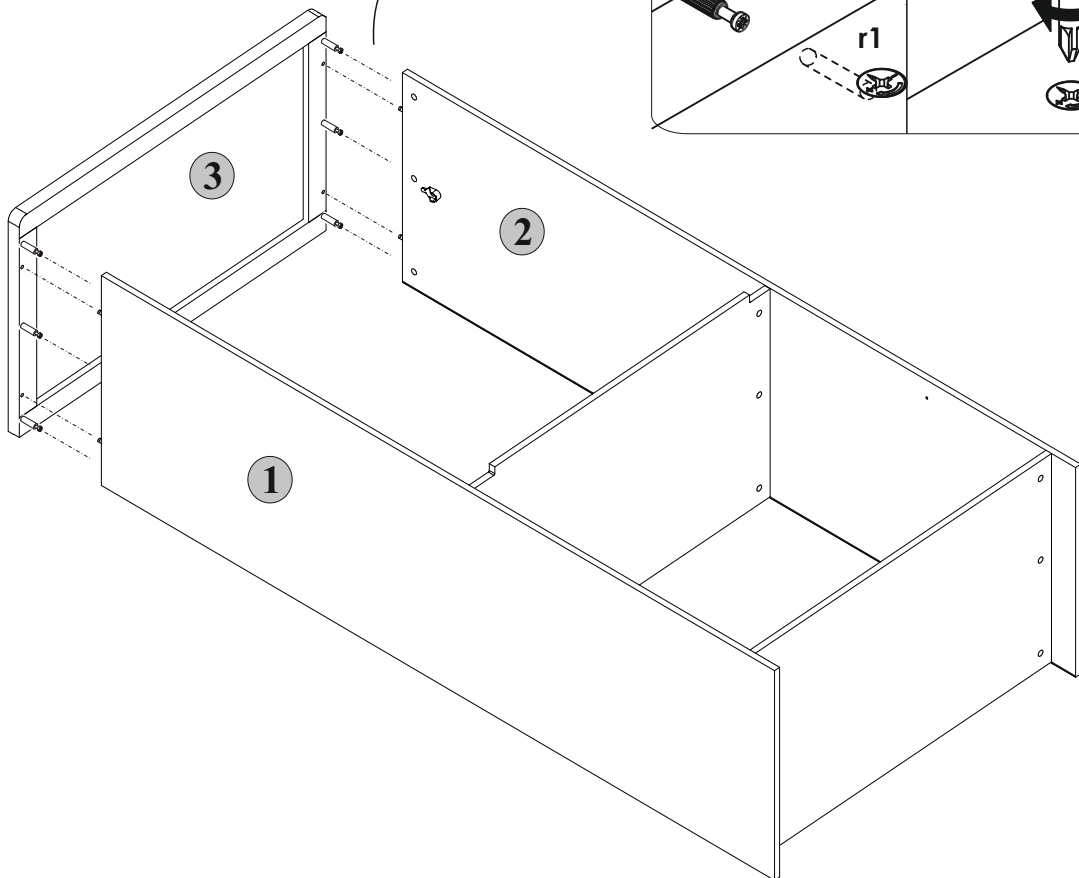
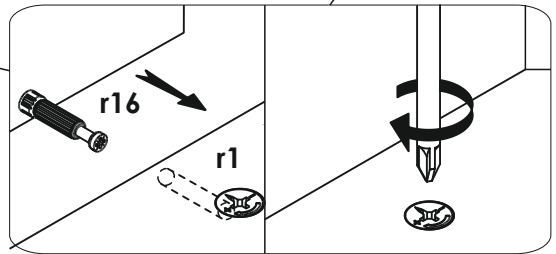
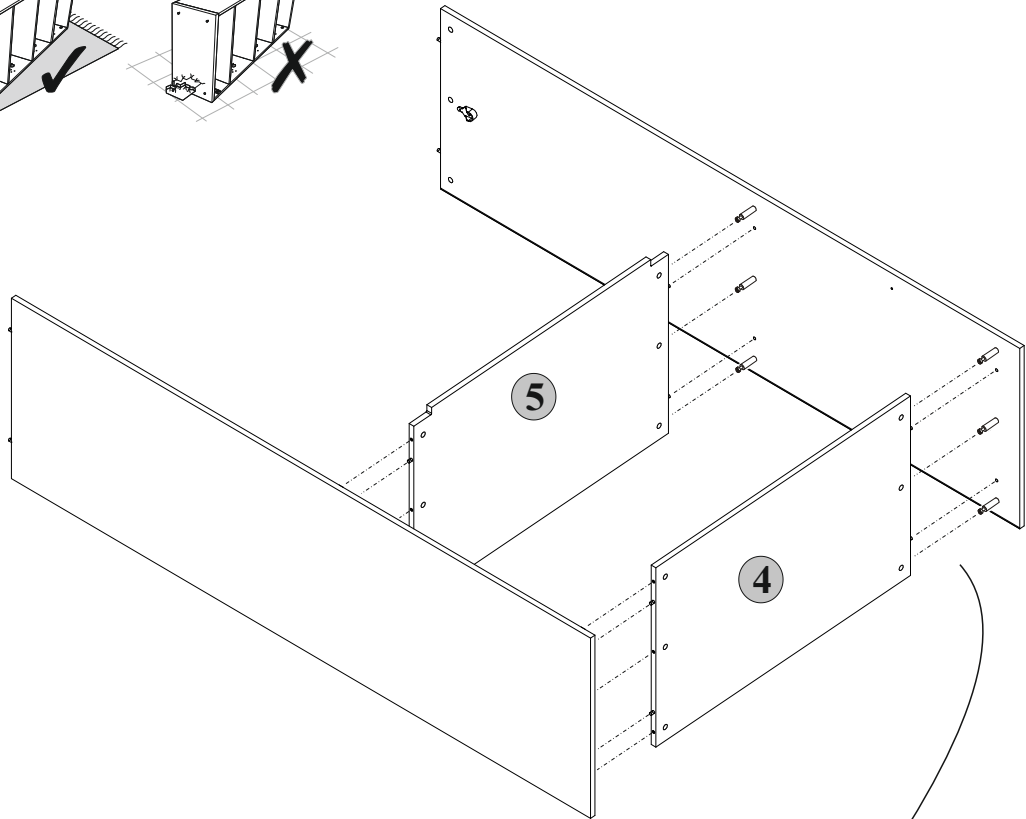
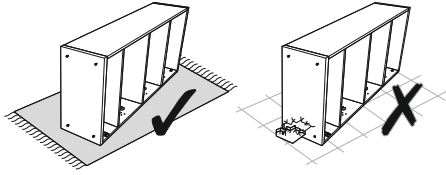

5

6

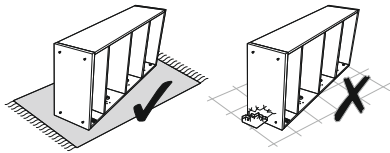

p3  x20
φ3.5x16 mm

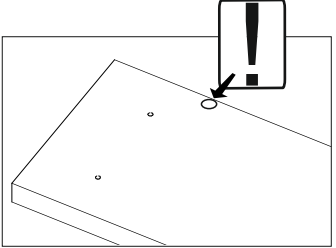
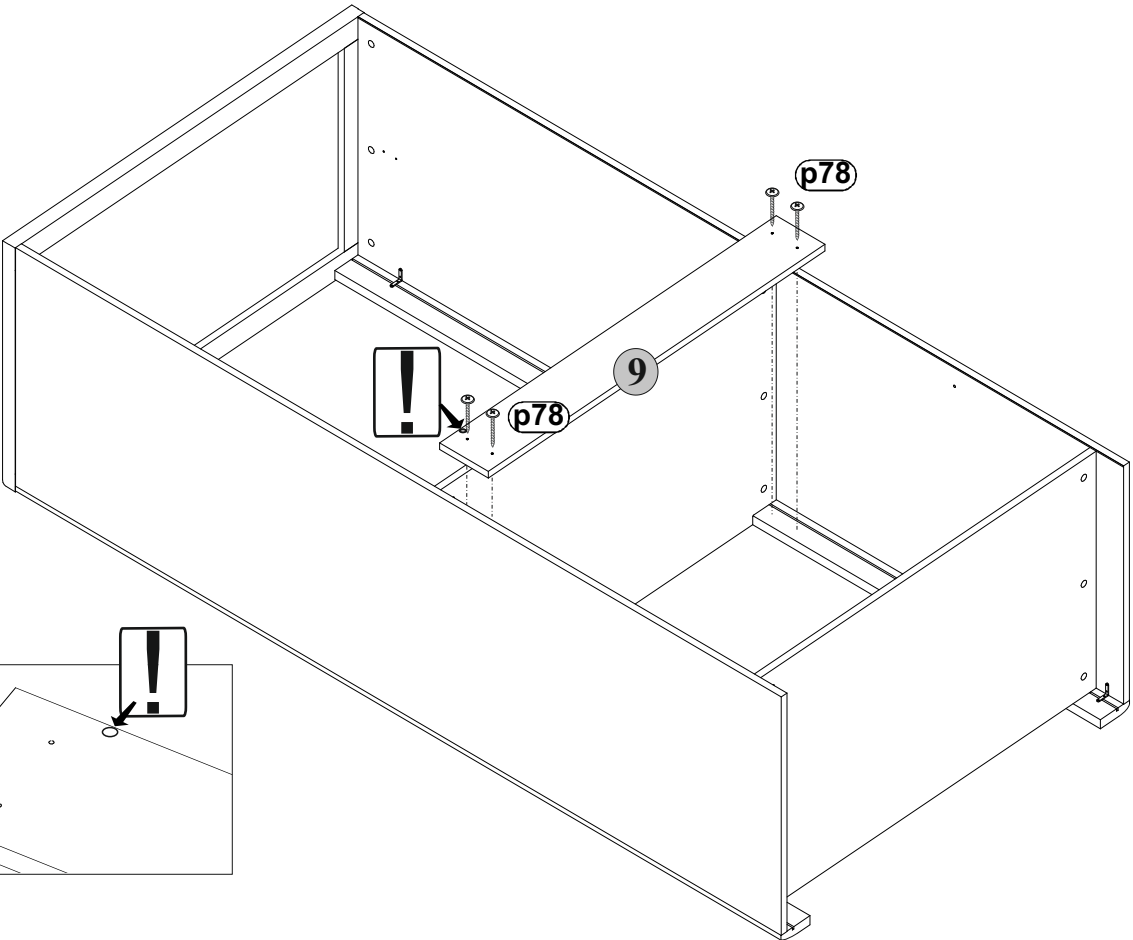
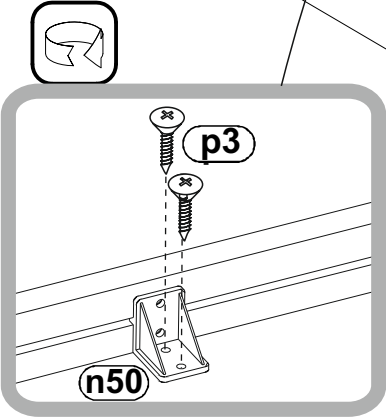
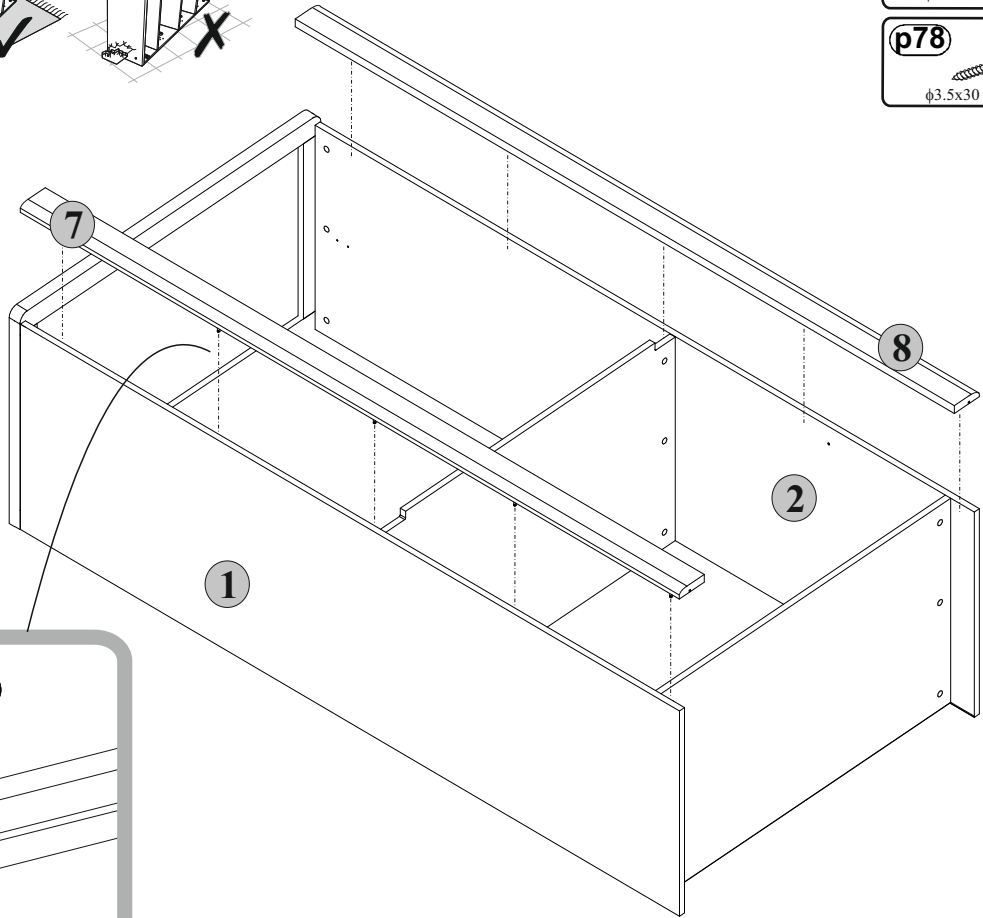

p78  x4
φ3.5x30 mm

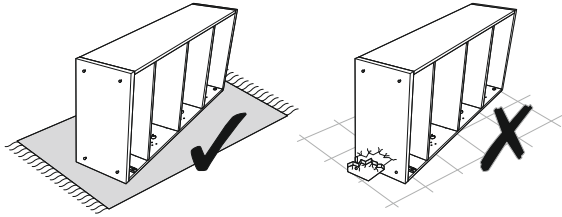

6

7



- l1**  x100
- k1**  x4

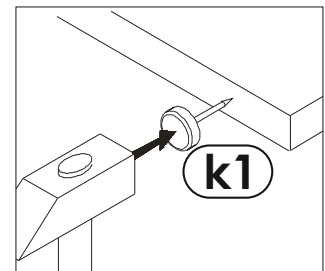
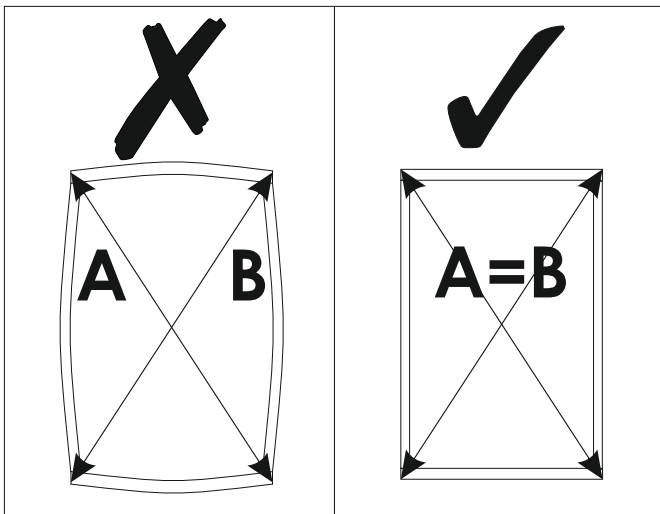
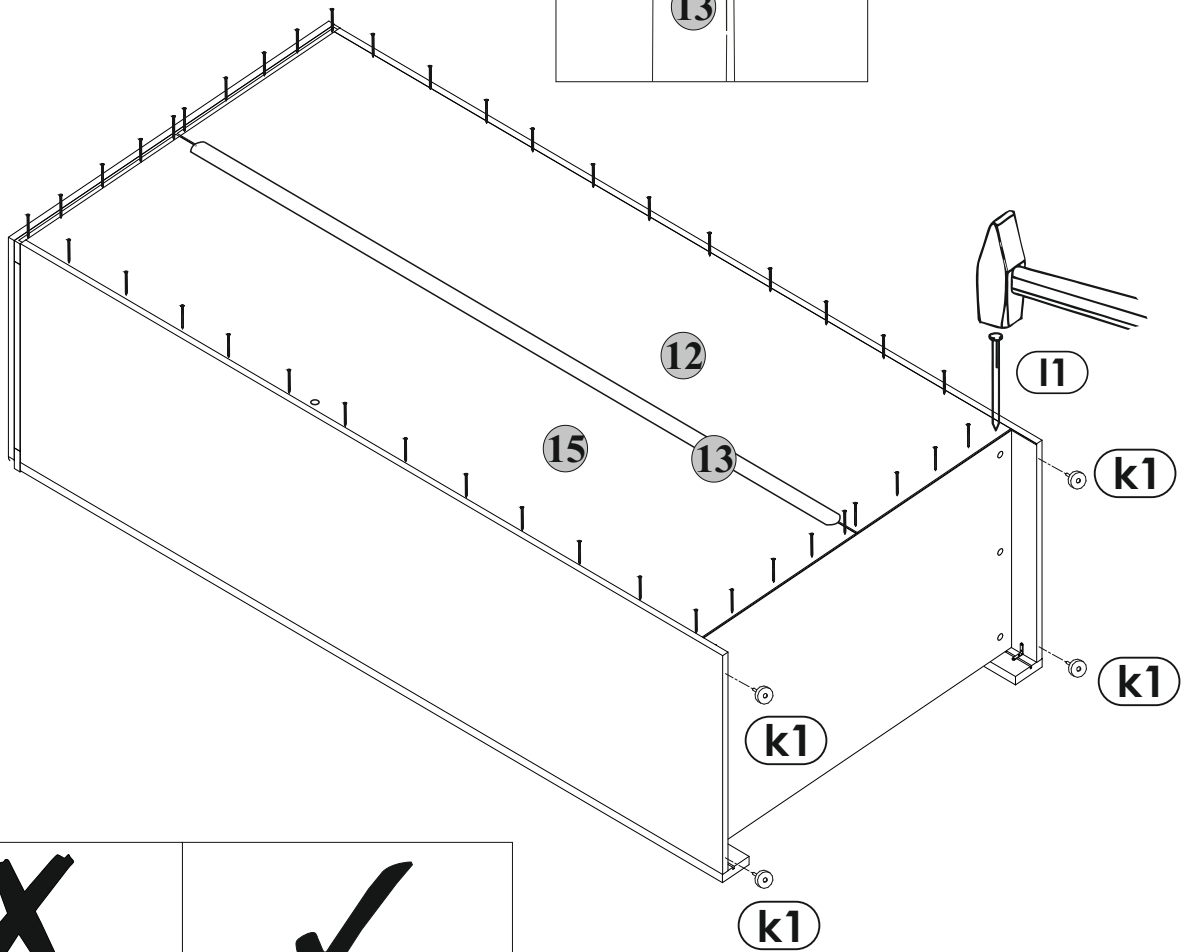
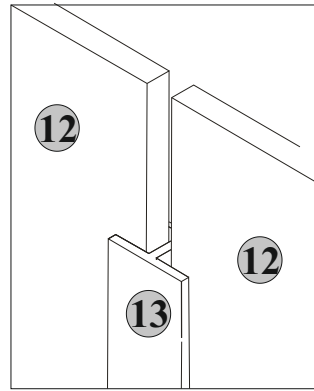

7

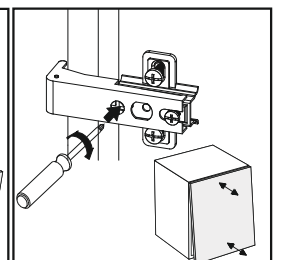
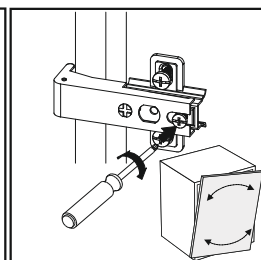
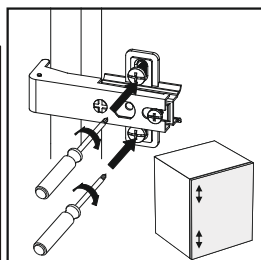
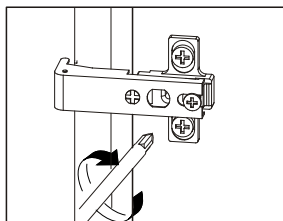
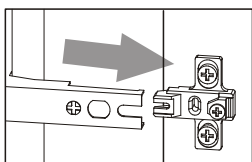
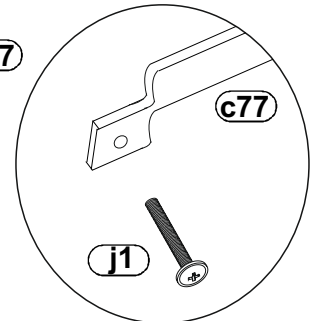
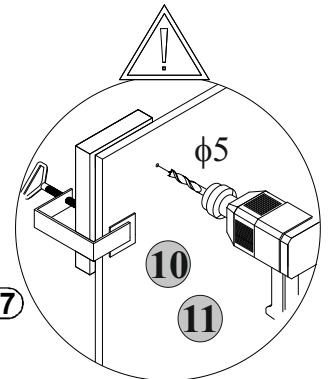
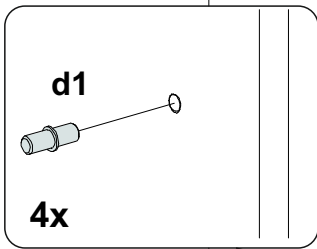
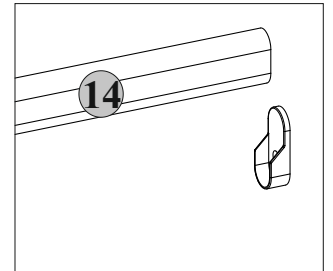
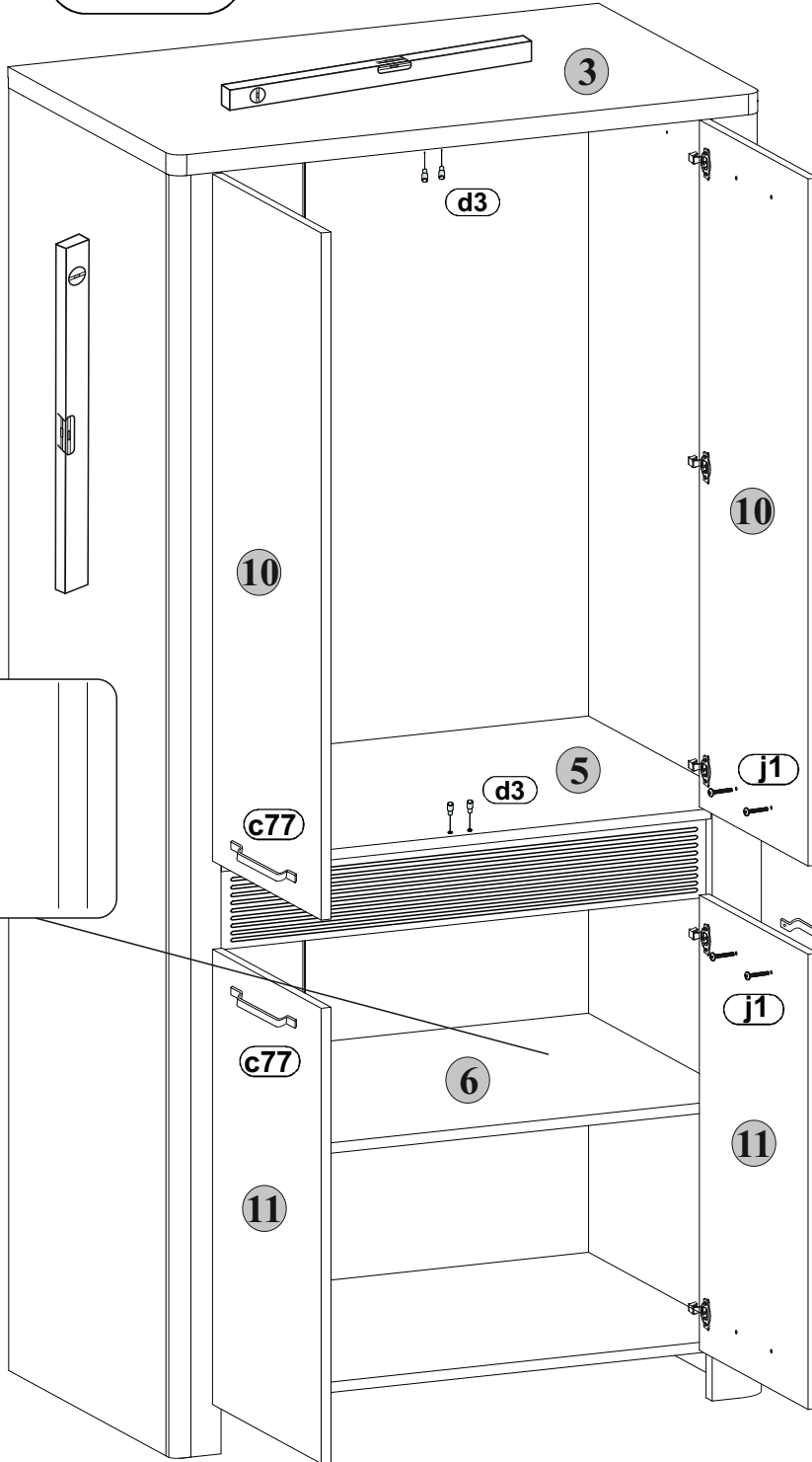
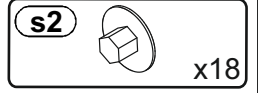
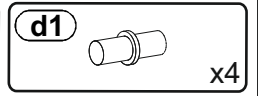
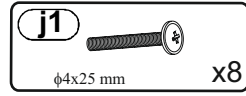
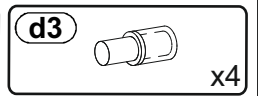
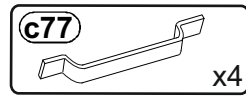
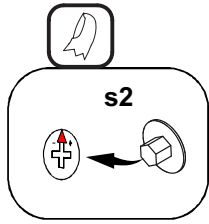

OPTION

Option

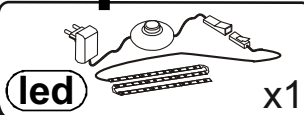

led x1

