

LINGO

Typ X

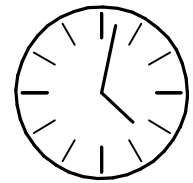

50 min

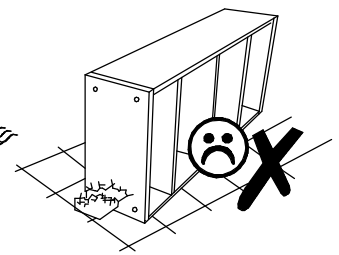
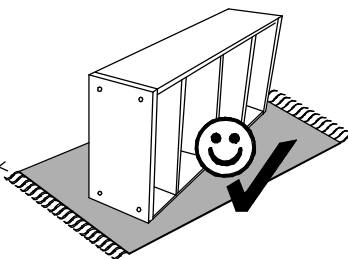
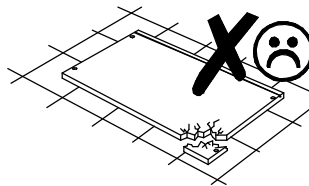
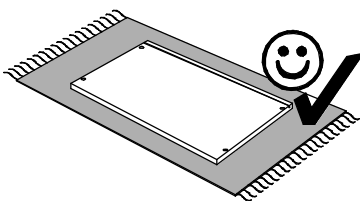
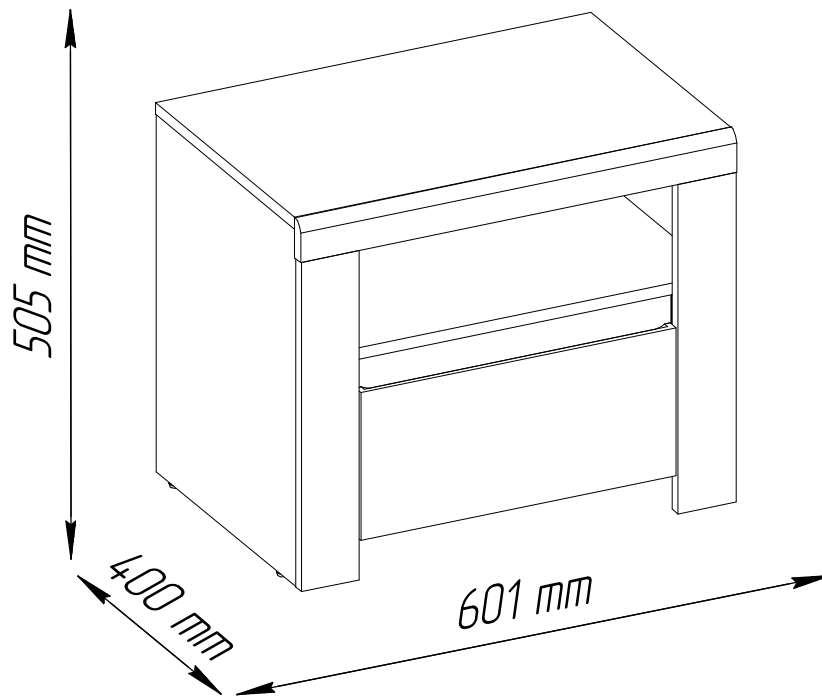
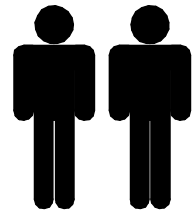

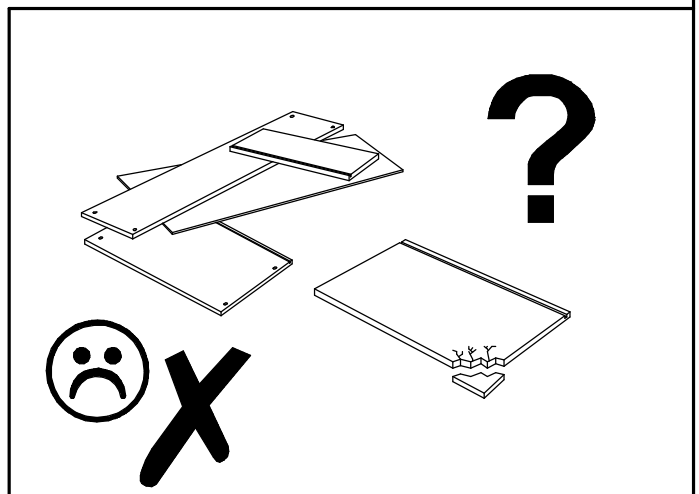
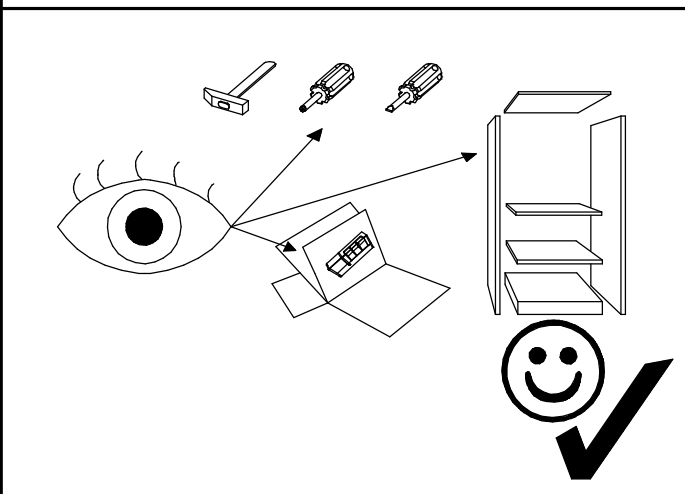
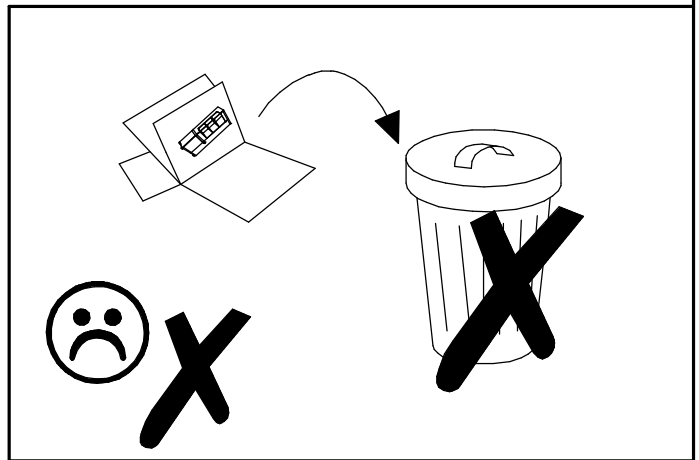
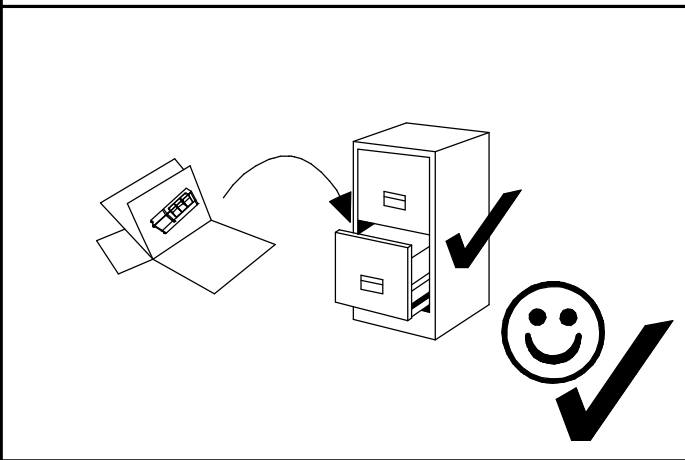
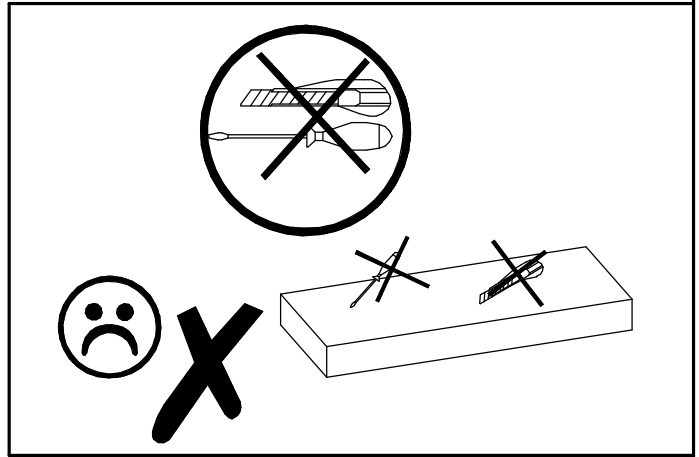
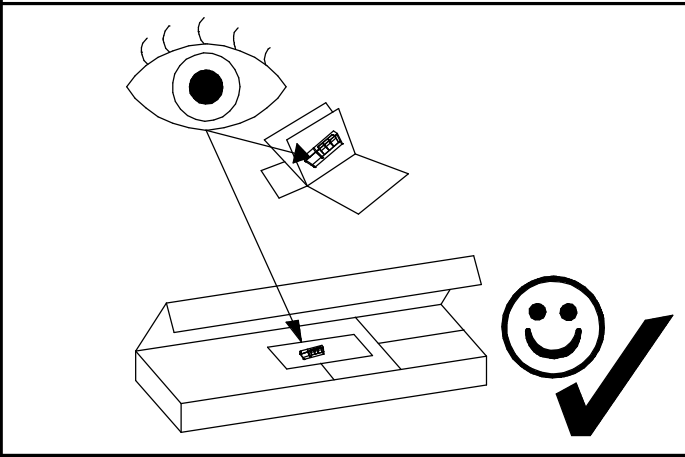

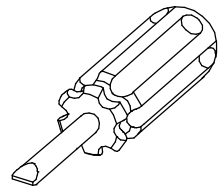
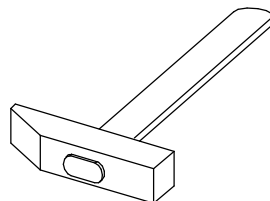
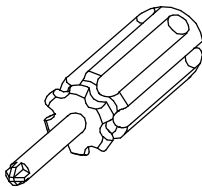
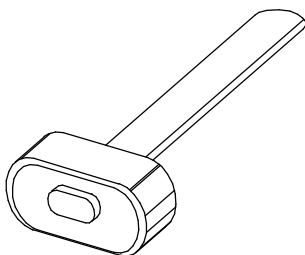
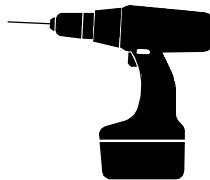
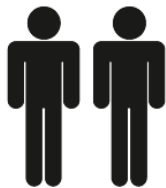
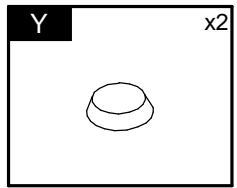
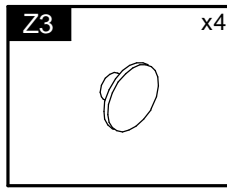
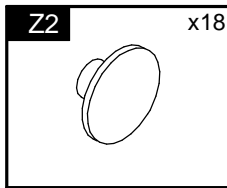
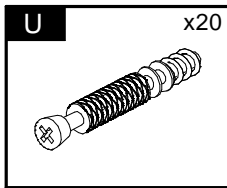
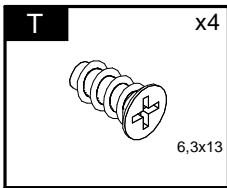
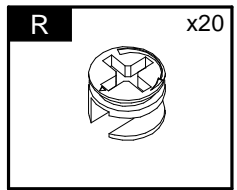
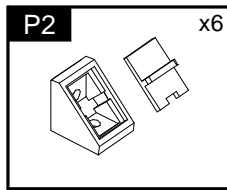
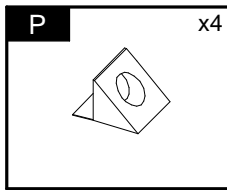
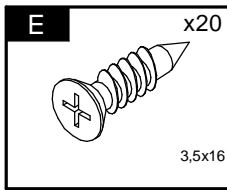
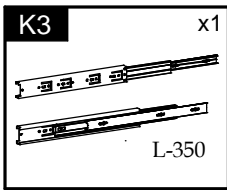
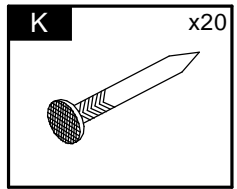
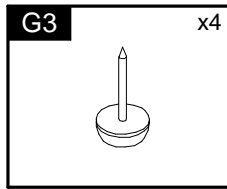
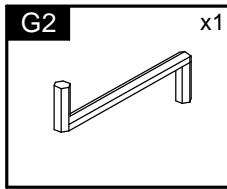
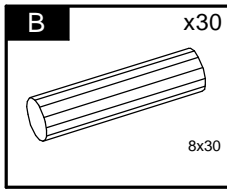
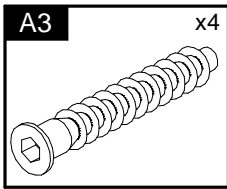
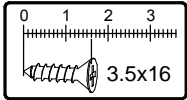

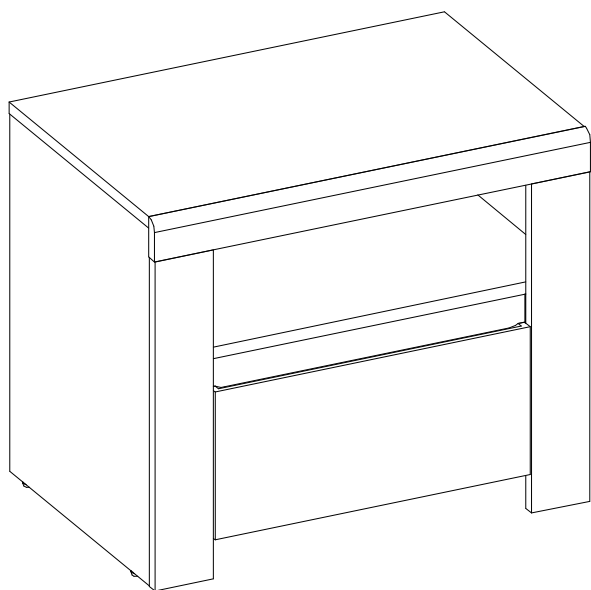

| Element symbol | Measurements | | | | Code | Paket |
|----------------|--------------|------|----|---|-----------|-------|
| | 1 | 2 | 3 | 4 | | |
| 1 | 600 | 384 | 16 | 1 | 1004 | 1/1 |
| 2 | 484 | 384 | 16 | 1 | 1002 | 1/1 |
| 3 | 484 | 384 | 16 | 1 | 1003 | 1/1 |
| 4 | 566 | 364 | 16 | 1 | 1005/2005 | 1/1 |
| 5 | 566 | 364 | 16 | 1 | 1024 | 1/1 |
| 6 | 224 | 364 | 16 | 1 | 1025 | 1/1 |
| 7 | 224 | 364 | 16 | 1 | 1026 | 1/1 |
| 8 | 437 | 65 | 16 | 1 | 1032 | 1/1 |
| 9 | 350 | 100 | 16 | 1 | 1028/2028 | 1/1 |
| 10 | 379.5 | 100 | 16 | 1 | 1029 | 1/1 |
| 11 | 350 | 100 | 16 | 1 | 1030/2030 | 1/1 |
| 12 | 439 | 580 | 3 | 1 | N/A | 1/1 |
| 13 | 411 | 354 | 3 | 1 | N/A | 1/1 |
| 14 | 436 | 202 | 16 | 1 | 1030/3001 | 1/1 |
| 15 | 447 | 82 | 16 | 1 | 1031/3002 | 1/1 |
| 16 | 447 | 82 | 16 | 1 | 1031/3003 | 1/1 |
| 17 | 602 | 56.5 | 19 | 1 | 1032/3004 | 1/1 |

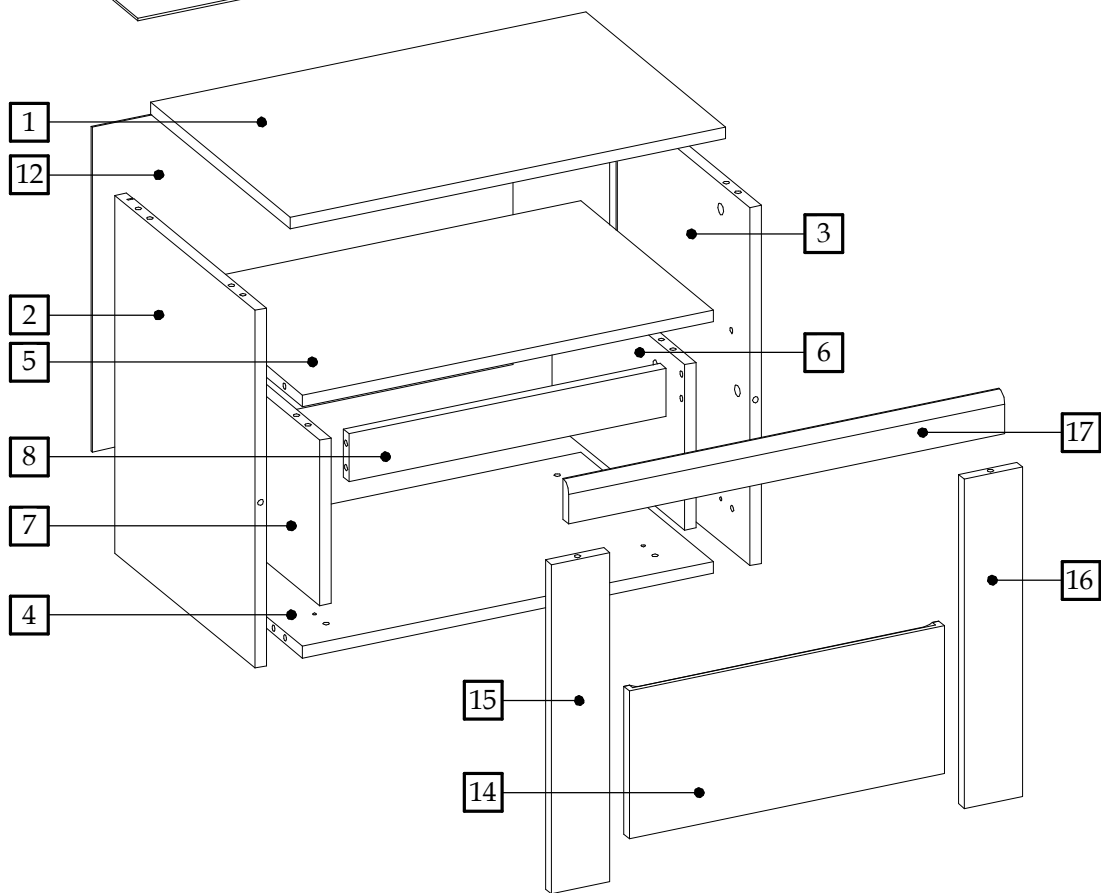
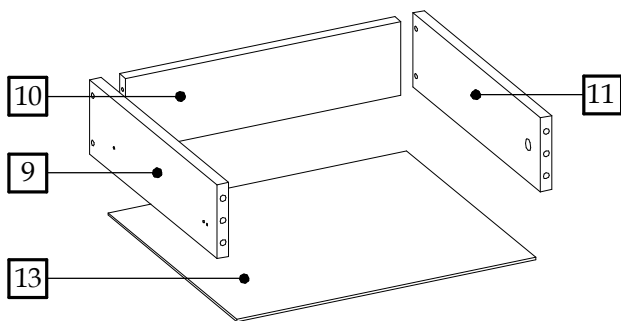

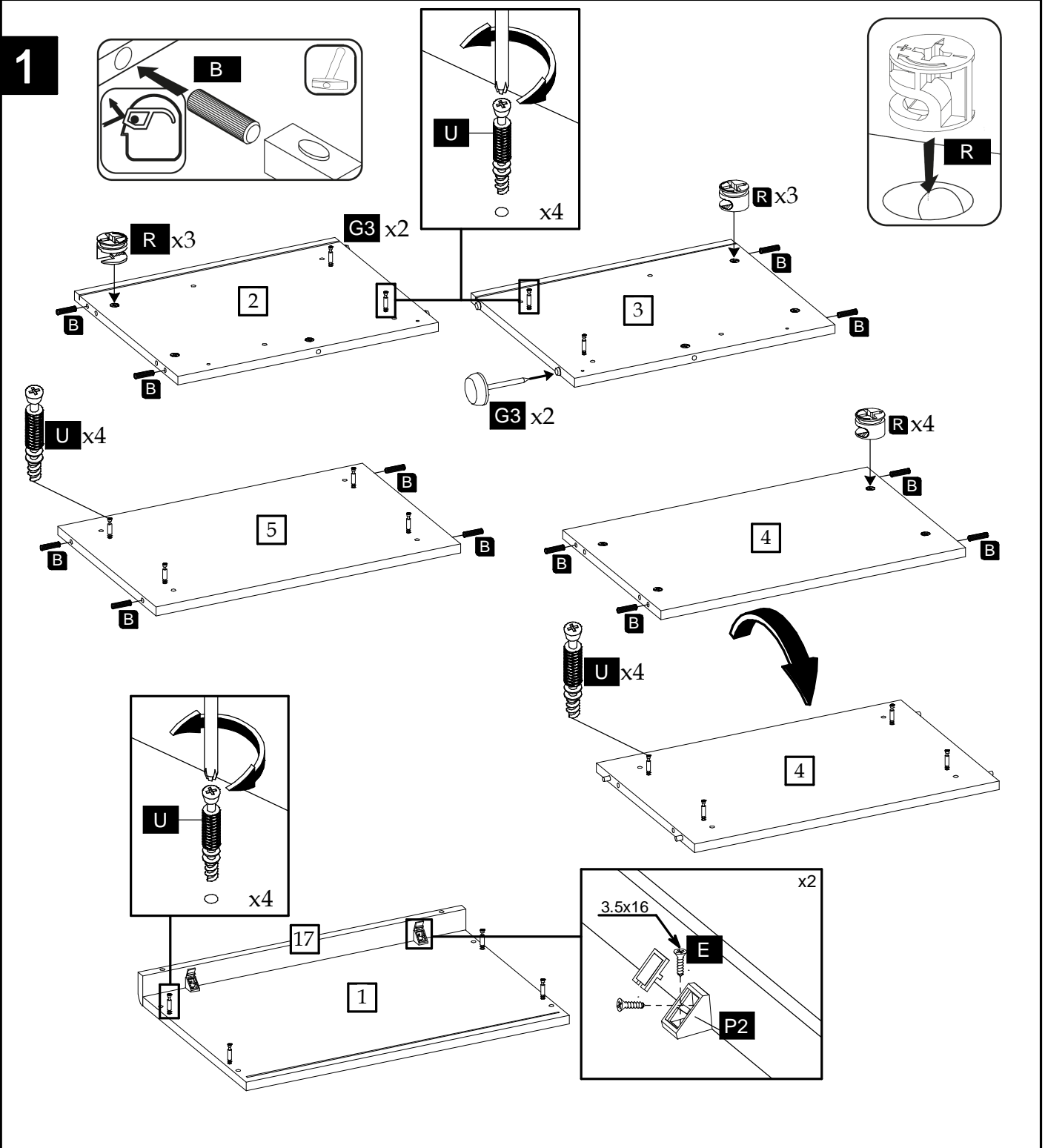
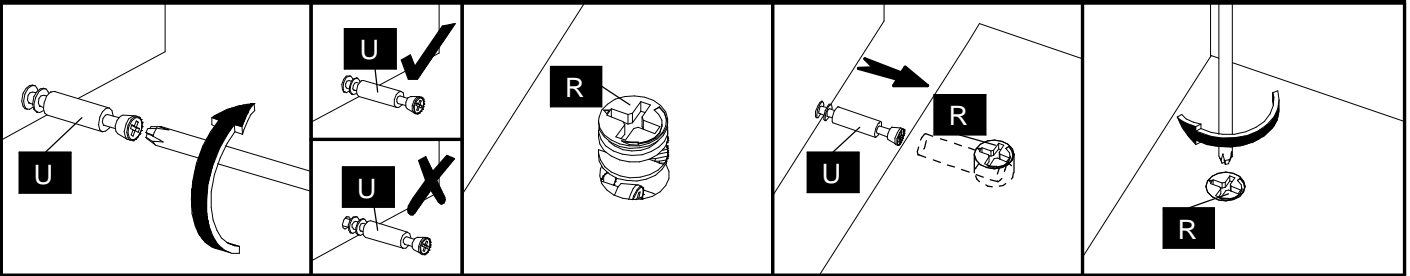

2

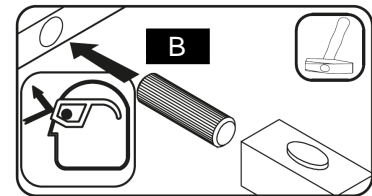
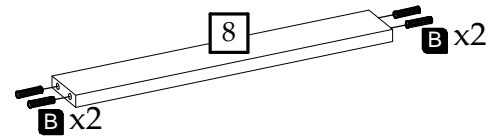
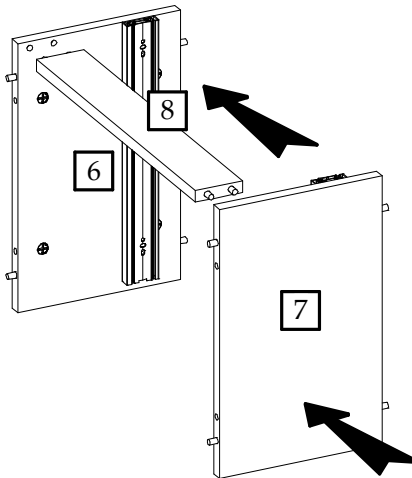
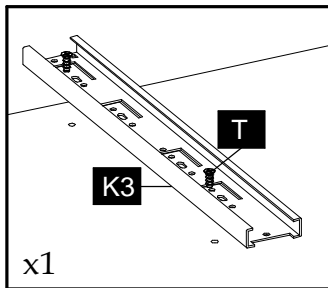
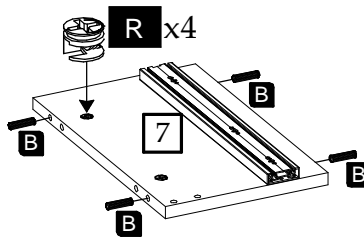
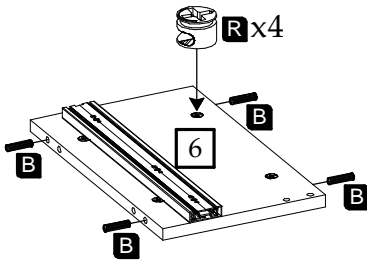
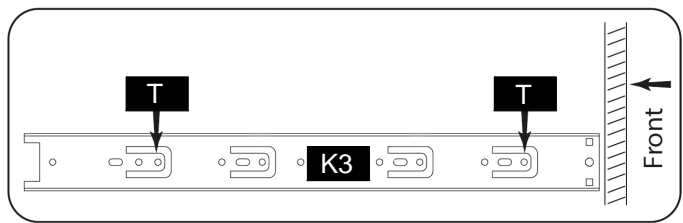
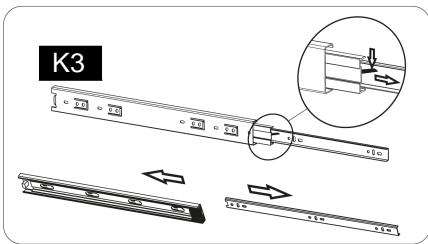

3

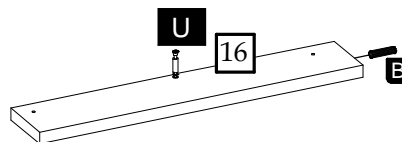
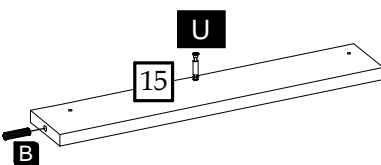
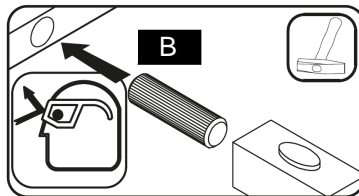
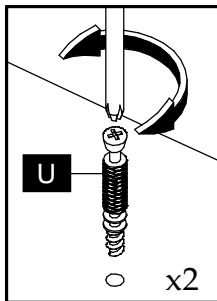
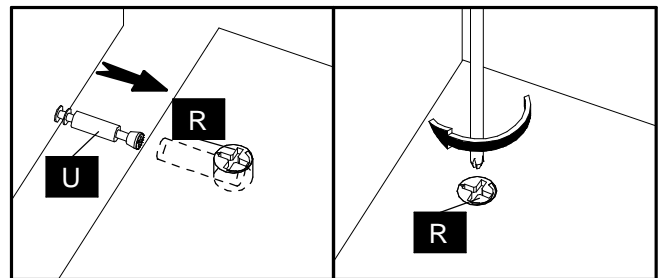
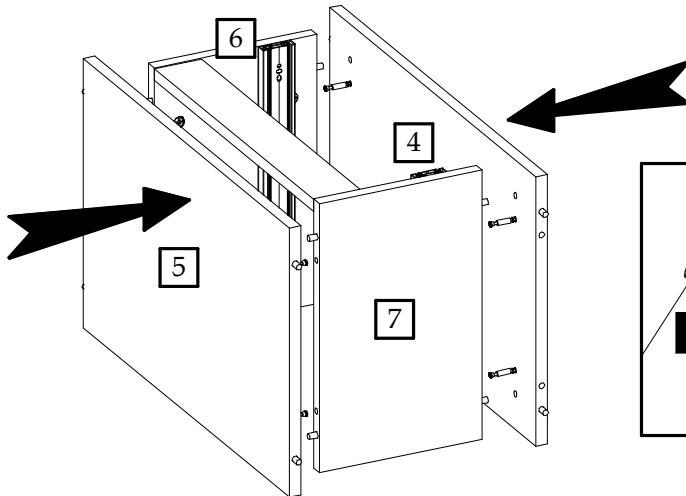

4

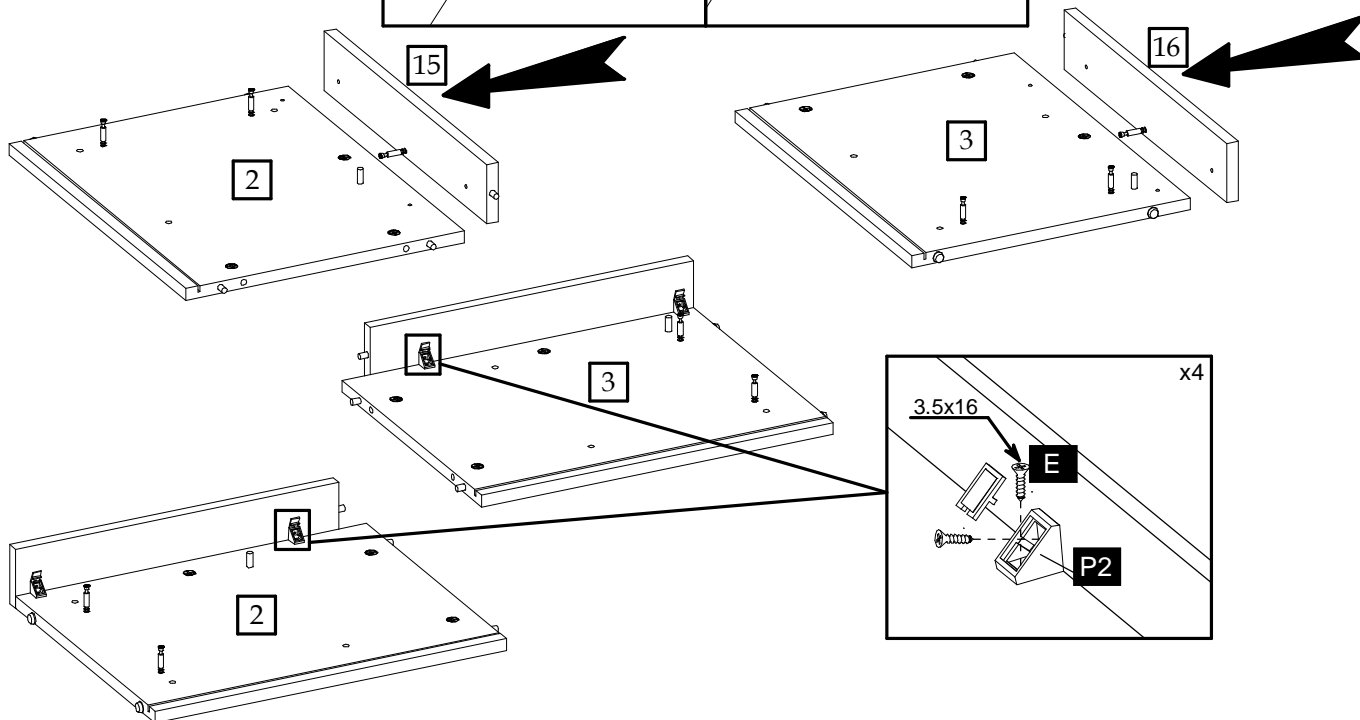
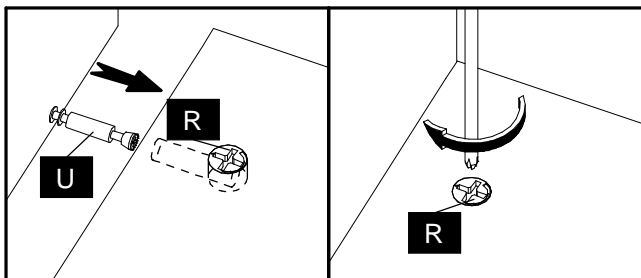

5

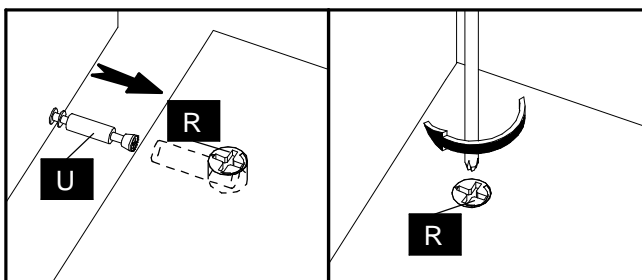
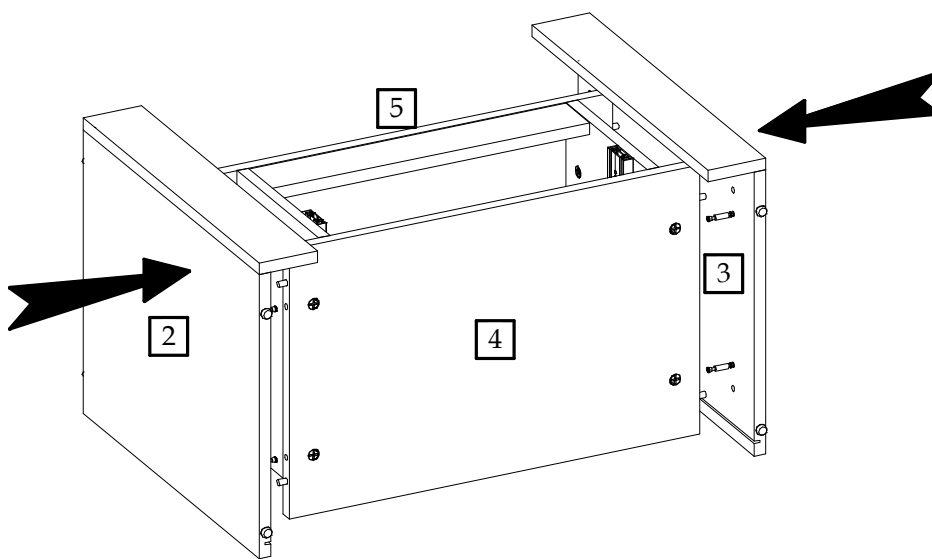

6

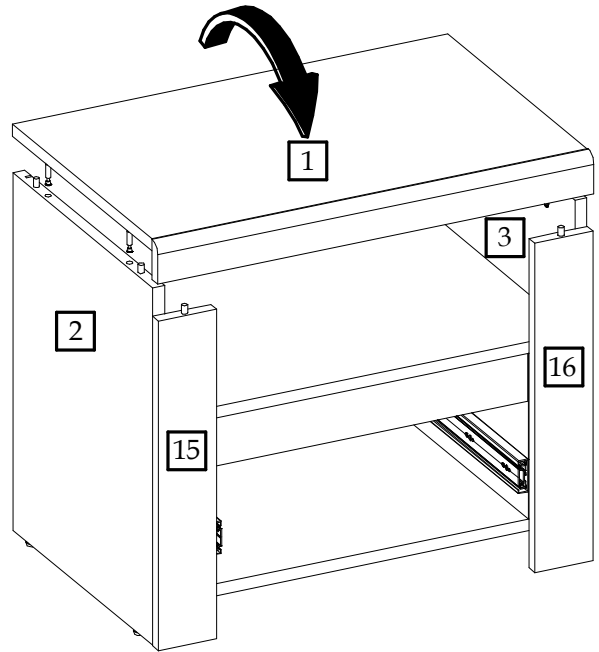
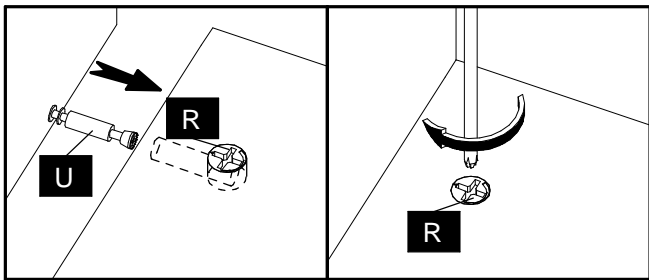

7

