

Instructions for assembling furniture Instrukcja montażu mebli

Collection Kolecja mebli

«DIESEL»

Regał otwarty 1D1S
Cupboard 1D1S

AH-029.48.00.00

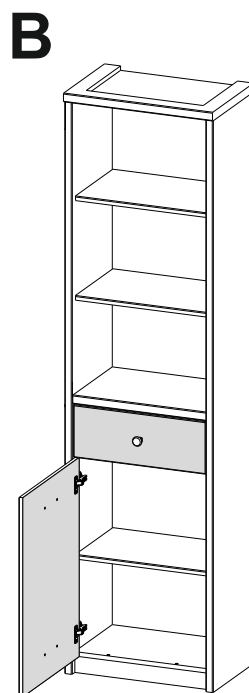
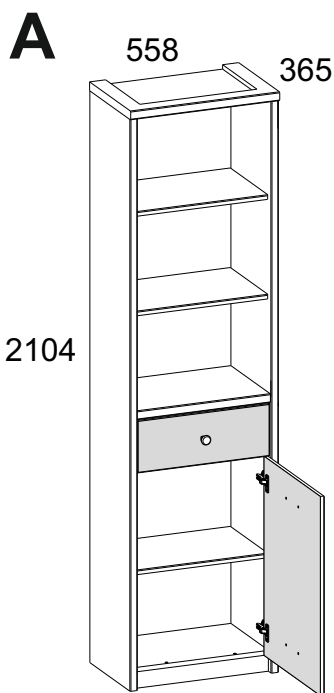

Production date
Data produkcji

Stamp of Quality Department
Pieczęć Działu Jakości

PL

Przy eksploatacji mebli zabrania się:

- ustawiać meble w pobliżu grzewczych przyrządów i obok wilgotnych ścian, a także w pomieszczeniach ze względną wilgotnością więcej niż 70%;
- temperatura nagrzewania elementów mebli nie może przekraczać +40°C;
- w trakcie montażu i eksploatacji mebli stawać nogami na poziome panele i witryny;
- stosować chemiczne środki czyszczące do sprzątania mebli;
- nie należy narażać na kontakt z wodą.

Gwarancje producenta.

1. Gwarancyjny termin eksploatacji wyrobu - 24 miesiące z dnia sprzedaży. W okresie gwarancyjnego terminu producent gwarantuje naprawę wyrobów lub ich zamianę, jeżeli reguły eksploatacji nie zostały naruszone przez nabywcę.
2. Roszczenia są przekazywane przez nabywcę bezpośrednio do handlującej organizacji, w której były nabyte meble, tylko przy okazaniu danej "Instrukcji montażu" wraz z dokumentem zakupu.
3. Wyrób **Regał otwarty 1D1S**, wchodzące w zestaw mebli „**DIESEL**”, odpowiada wymaganiom Norm Państwowych 16371-2014, TP TC 025/2012
4. Trwałość użytkowa mebli - 5 lat.
5. Firma-producent pozostawia za sobą prawo do wprowadzania zmian w konstrukcje wyrobów, nie pogarszając ich konstruktywne i eksploatacyjne charakterystyki.
6. Do montażu wyrobów zaleca się skorzystanie z pomocy wykwalifikowanych specjalistów.

Zapach.

Nowe meble mogą wydzielać zapach materiałów, z których są wykonane. Zapach może utrzymywać się do trzech tygodni od momentu montażu. Aby zmniejszyć intensywność zapachu, zaleca się:

- w przypadku mebli tapicerowanych - odkurzyć produkt i przewietrzyć pomieszczenie. Powtarzaj 3-4 razy dziennie.
- dla mebli szafkowych - przetrzyj ściereczką zwilżoną łagodnym detergentem, przetrzyj czystą, suchą ściereczką i przewietrz pomieszczenie, uprzednio otwierając wszystkie drzwi i szuflady produktu. Powtarzaj 3-4 razy dziennie.

Ważne! Proszę zachować instrukcję w razie ponownego montażu mebli lub reklamacji. Podczas składania reklamacji prosimy o korzystanie z oznaczeń z instrukcji.

EN

Instruction manual.

It's advised to check the quality and completeness of the product in the store when buying unpacked. Assembling of the product should be done the way it's described in this manual. While the product is in service loose screw connections should be periodically tightened. If it's necessary to move items around the apartment before moving you should release the product completely from the load (the mattress). To prevent damage to existing supports the product should be lifted before moving. Furniture should not be exposed to contact with water. Dusting the product should be done with a slightly damp soft cloth. To prevent warping of parts and discoloration of products do not install furniture in direct sunlight.

While the product is in service it's PROHIBITED TO:

- Install furniture near heating devices, close to the raw walls and in rooms with a relative humidity of more than 70%;
- heat elements of furniture to the temperature higher +40°C;
- step on the horizontal shields and windows during assembly and use of the products set;
- use chemical cleaners for cleaning furniture;

Manufacturer's warranty.

1. The warranty period of use of the product - 24 months from the date of sale. During the warranty period the manufacturer guarantees repair or replacement of products, if the user has not violated operating rules.
2. Claims should be made by the consumer directly to the trading organization, in which furniture was purchased, presenting the "Instruction manual" and a copy of the sales receipt.
3. The product **Cupboard 1D1S**, which is part of a set of „**DIESEL**”, meet the requirements of GOST 16371-2014, TR TS 025/2012.
4. The lifetime of furniture - 5 years.
5. The manufacturer reserves the right to make changes in product design, without compromising its design and application requirements.
6. To assemble the products it's recommended to attract qualified personnel.

Smell.

New furniture may emit the smell of the materials from which it is made. The smell can persist for up to three weeks from the time of assembly. To reduce odor intensity, it is recommended:

- for upholstered furniture - vacuum the product and ventilate the room. Repeat 3-4 times a day.
- for cabinet furniture - wipe with a cloth dampened in a mild detergent, wipe with a clean, dry cloth and ventilate the room, previously opening all doors and drawers of the product. Repeat 3-4 times a day.

It is important! Keep the instruction in case of reassembly of furniture or complaint. When making a claim use the notation from the instruction.

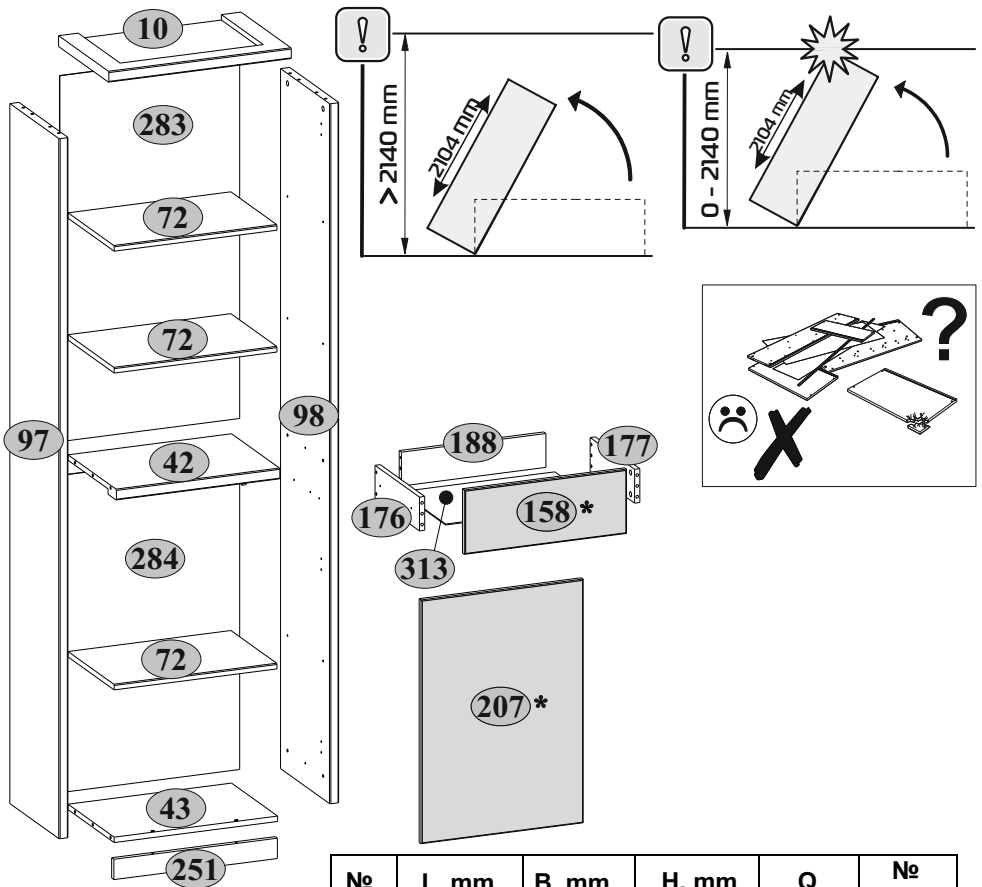







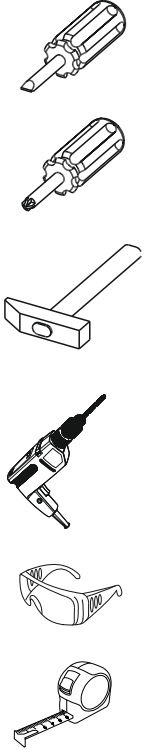



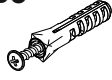
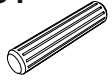









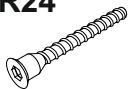

No	L, mm	B, mm	H, mm	Q	No pack
10	558	362	32	1	1/3
42	500	348	32	1	1/3
43	500	332	16	1	1/3
72	498	332	16	3	1/3
97	2068	355	28	1	2/3
98	2068	355	28	1	2/3
158*	496	190	16	1	1/1
176	320	100	16	1	1/3
177	320	100	16	1	1/3
188	442	100	16	1	1/3
207*	496	720	16	1	1/1
251	500	60	16	1	1/3
283	1081	550	2,5	1	3/3
284	937	550	2,5	1	3/3
313	472	325	2,5	1	1/3

*There is an option of ordering fronts in various colours.

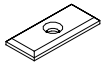
*Jest opcja zamówienia frontów w różnych kolorach.

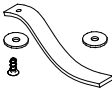

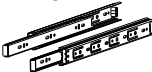
A1.0  5x28 12	A2  Ø15x13 12	B5  10x50 1	C1  8x35 16
D1  2	E6  2	G  1,5x26 22	H23  1
H24  1	I  S4 1	L1  320 1	M4  M4x22 1
M14  M4x14 2	N1  4	P1  Ø5 12	Q  1,5x7 2
R3  3x20 11	R23  6,3x13 4	R24  7x50 6	R27  5,0x13 10
R102  3,5x16 6	S3  3	S5  Ø18 8	S6  1
S9  Ø12 2	S11  Ø8 4	Z10  300 1	

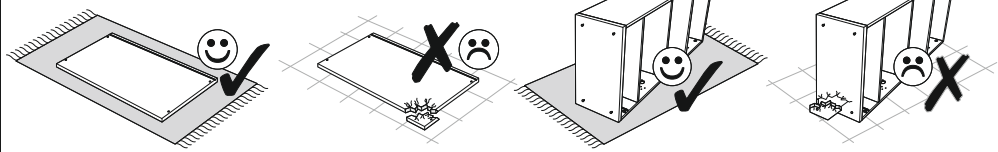
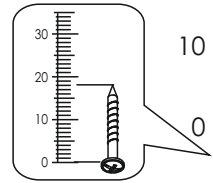
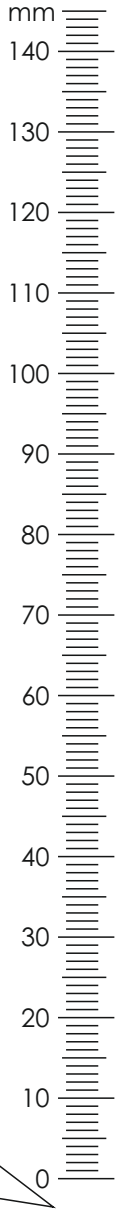

1**A****A1.0**

5x28

A2

4

Ø15x13

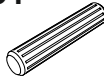
C1

4

8x35

D1

4

P1

2

Ø5

12

R23

6,3x13

R27

4

5,0x13

6

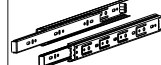
Z10





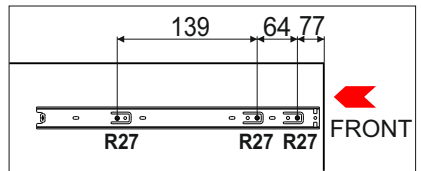
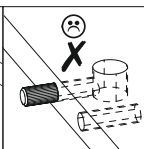
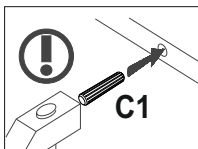
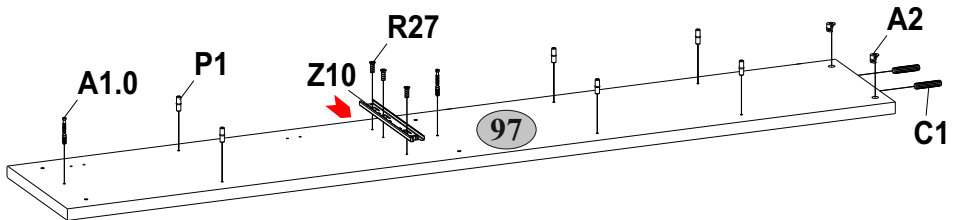
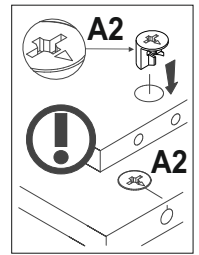
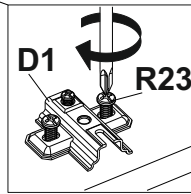
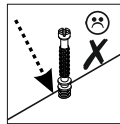
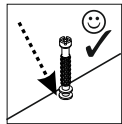
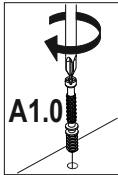
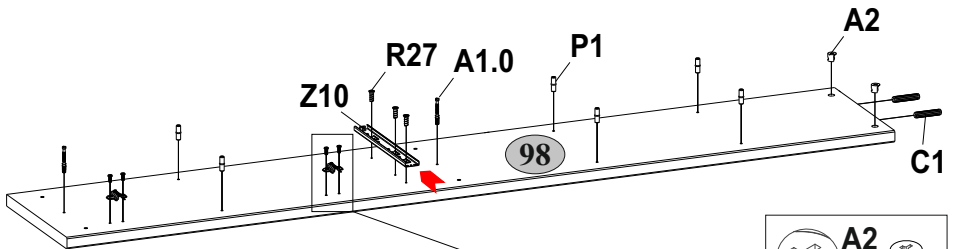
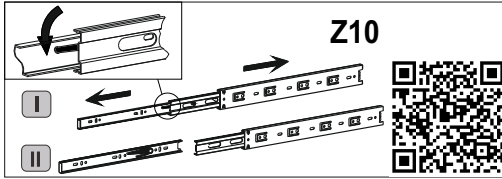

300

1



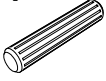
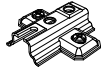

1

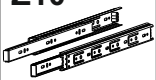
B

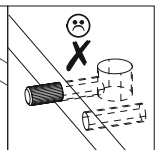
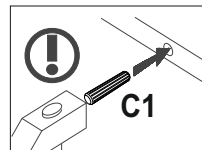
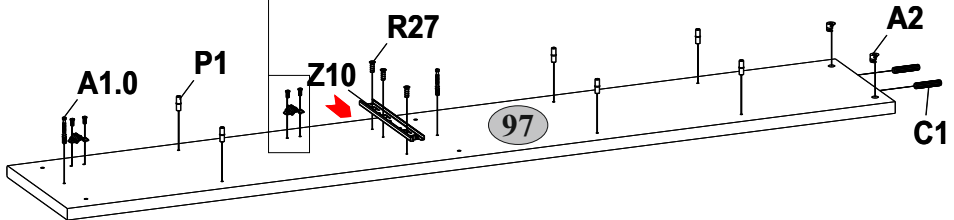
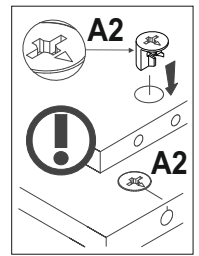
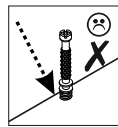
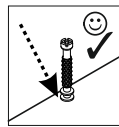
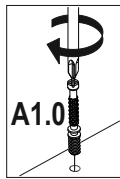
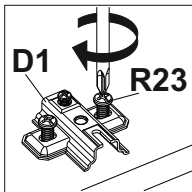
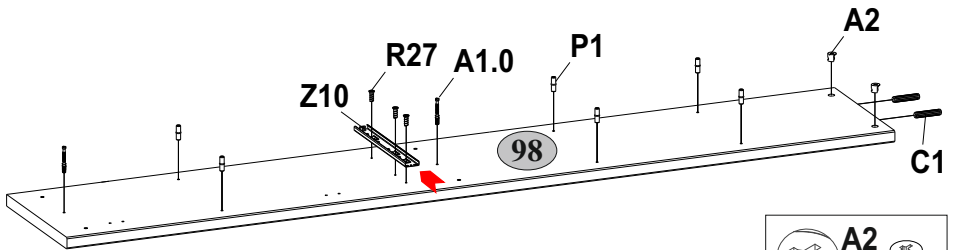
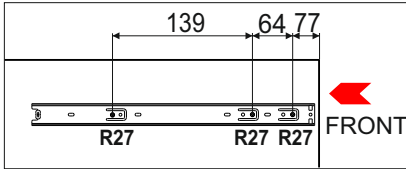
A1.0  5x28	A2  4 Ø15x13	C1  4 8x35	D1  2	P1  12 Ø5
R23  6,3x13	R27  4 5,0x13	Z10  300 1		



2

A2  Ø15x13	C1  4 8x35
--	--

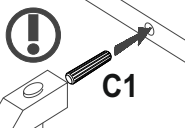
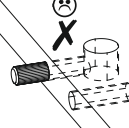

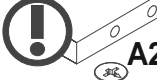
 C1	 X
--	---

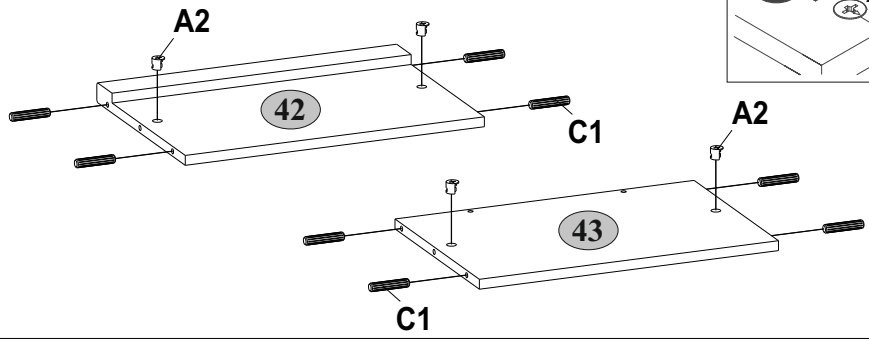
 A2	 X
---	--

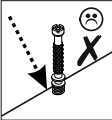

3

A1.0  5x28	4
--	----------

 A1.0	 X	 ✓
--	---	---

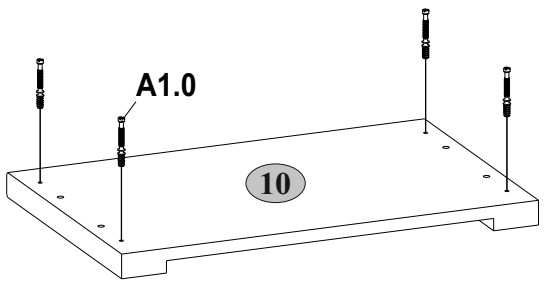

4

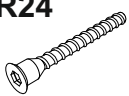
I  S4	1
R24  7x50	2

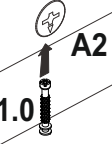
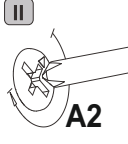
I  A1.0	II  A2
--	---

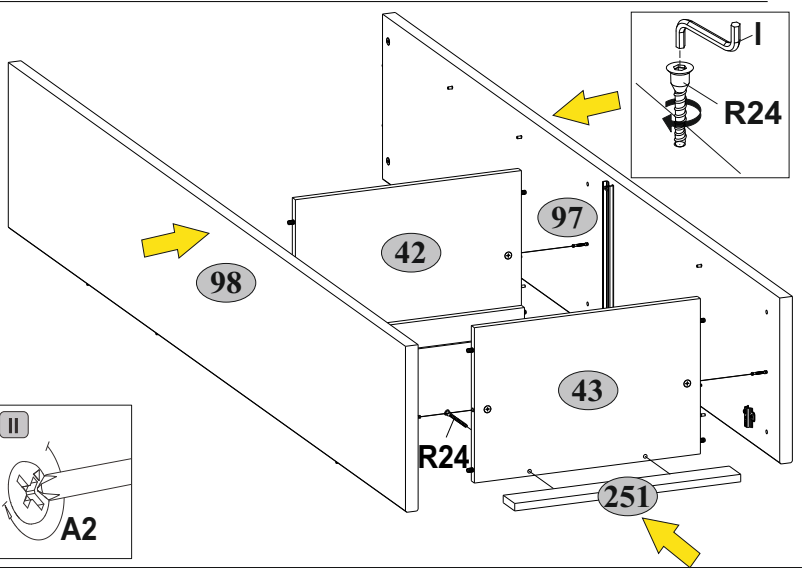

5

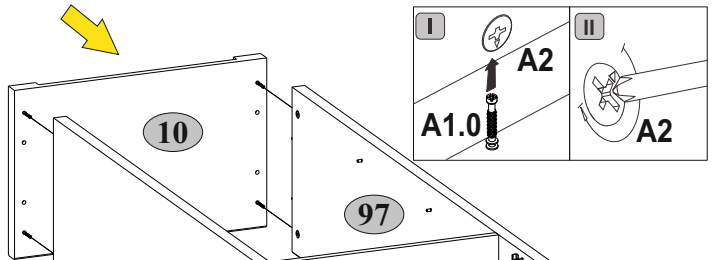

6

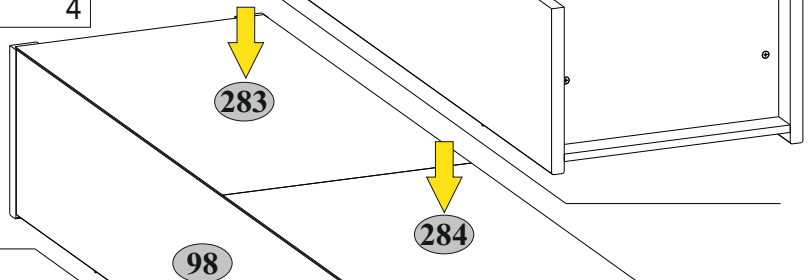
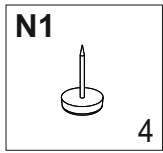



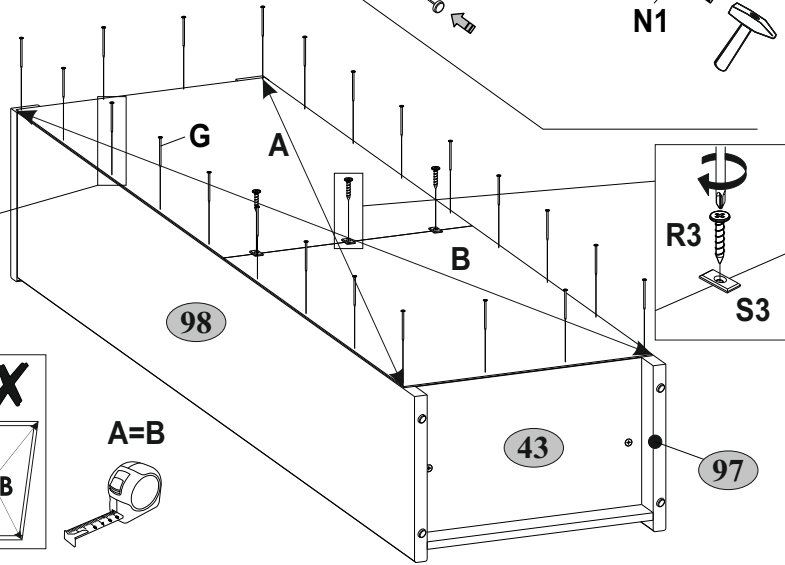
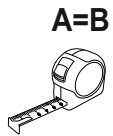
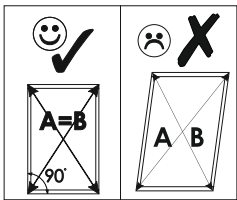
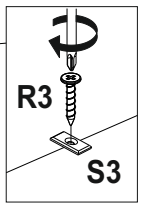
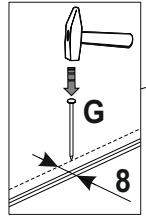
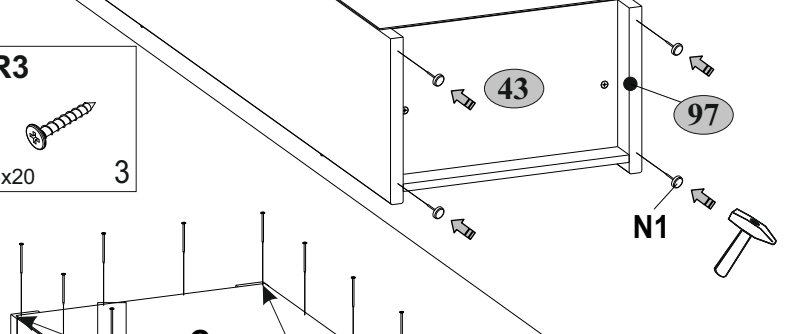
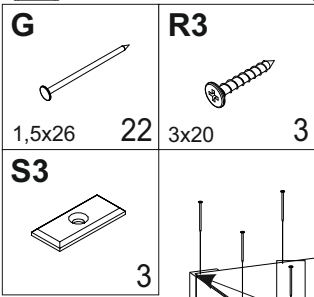

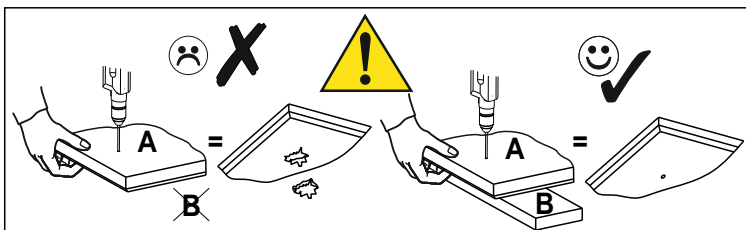
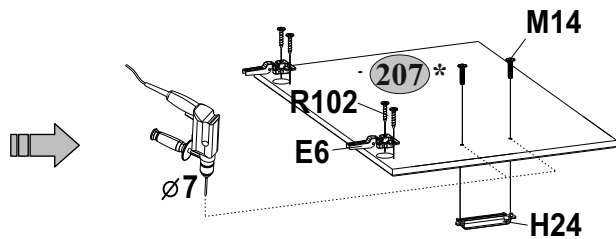
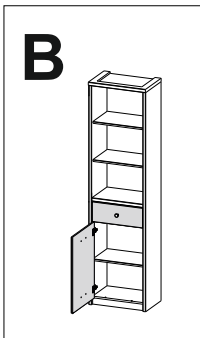
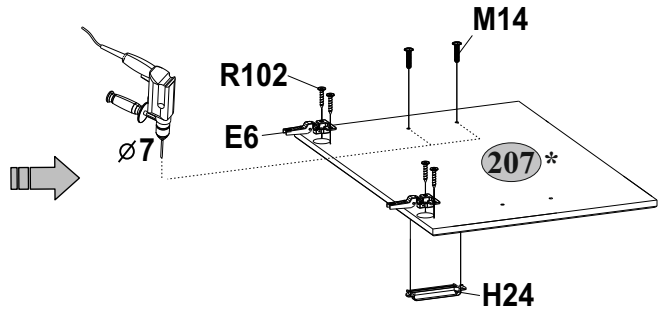
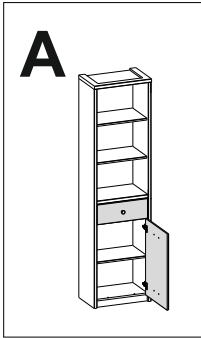
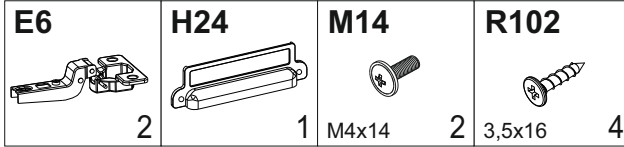



7

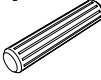

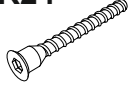

8

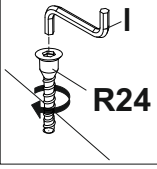
9

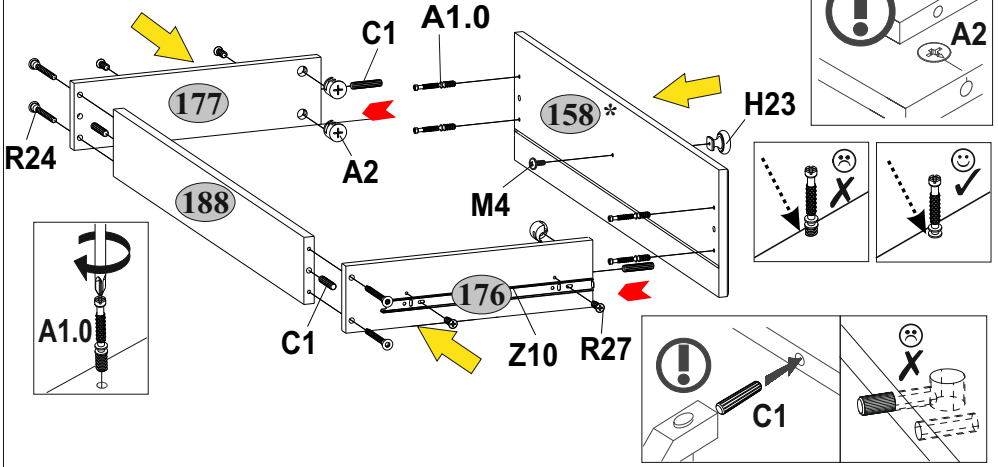
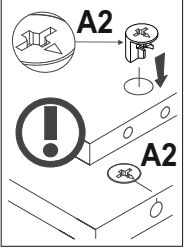
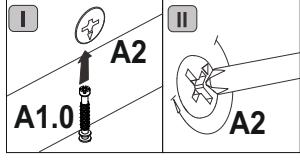
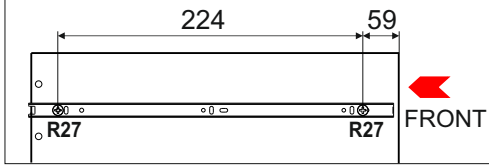
A1.0  5x28 4	A2  Ø15x13 4	C1  8x35 4	H23  1	I  S4 1
M4  M4x22 1	R24  7x50 4	R27  5,0x13 4	Z10  300 1	 R24





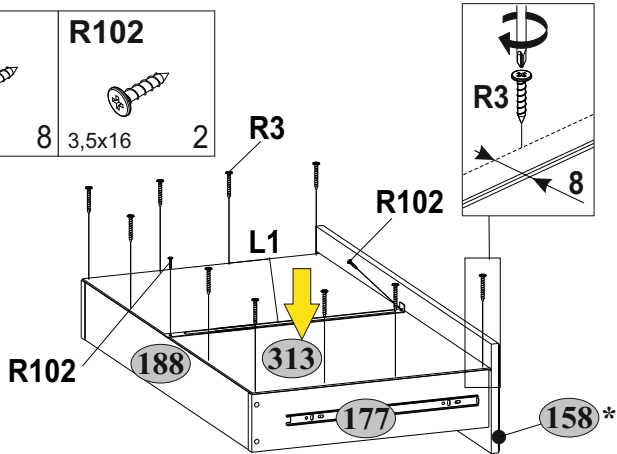
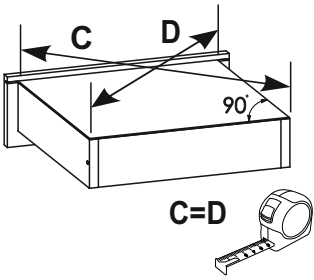

10



L1  320 1	R3  3x20 8	R102  3,5x16 2
---	--	--

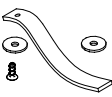



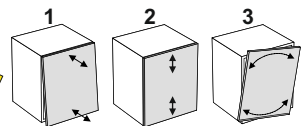
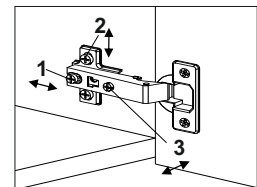
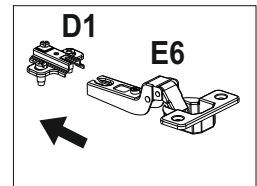
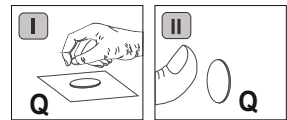
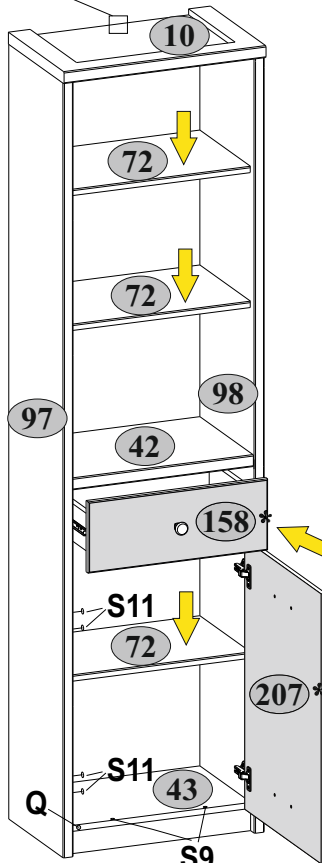
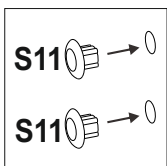
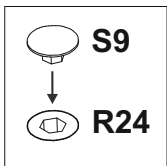
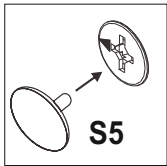
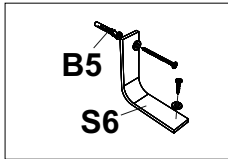
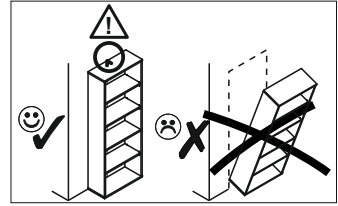

11**A**

B5  10x50 1	Q  1,5x7 2	S5  Ø18 8
S6  1	S9  Ø12 2	S11  Ø8 4



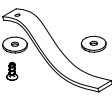

42 72 158*  max. 5 kg
 43  max. 10 kg

11**B**

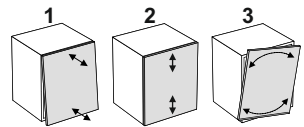
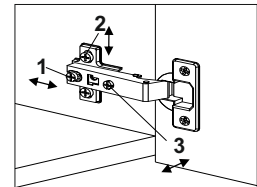
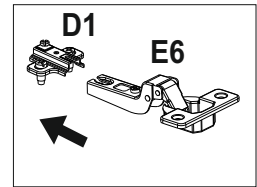
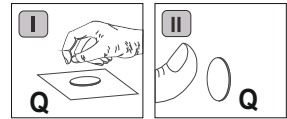
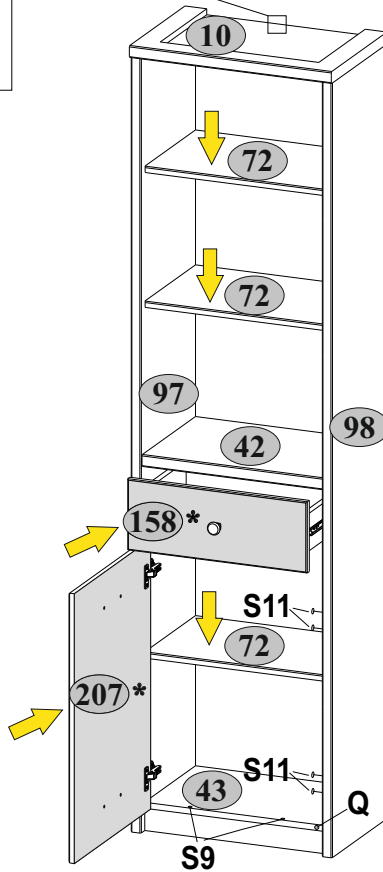
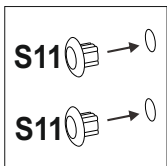
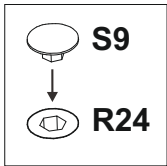
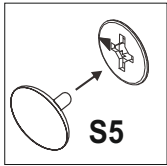
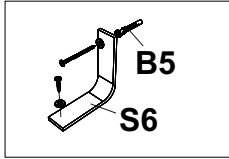
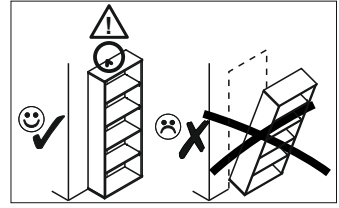
B5  10x50 1	Q  1,5x7 2	S5  Ø18 8
S6  1	S9  Ø12 2	S11  Ø8 4



42 72 158*  max. 5 kg
 43  max. 10 kg

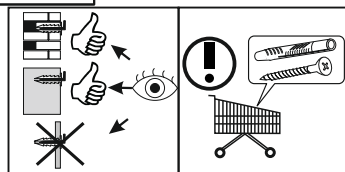
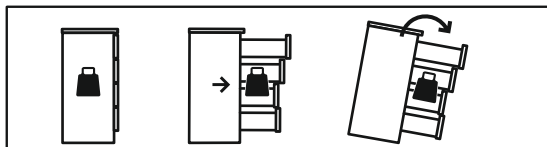

PL

OSTRZEŻENIE!

Przewrócenie się mebla może spowodować poważne lub śmiertelne obrażenia ciała na skutek przygniecenia.

ZAWSZE przymocuj ten mebel do ściany za pomocą ograniczników.

Kołek osadzony stosuje się do ścian z cegły i betonu. Do montażu na ścianie użyj łączników odpowiednich do materiału, z którego wykonana jest ściana, jeśli nie masz pewności, który rodzaj mocowania jest odpowiedni dla materiału ściennego, skontaktuj się ze specjalistą lub specjalistycznym sklepem. Ostatecznie za elementy złączne odpowiedzialny jest instalator.

Aby dodatkowo ograniczyć ryzyko poważnych obrażeń ciała i śmierci na skutek przewrócenia się mebla:

- Najcięższe przedmioty umieść w dolnej szufladzie.
- Nie kładź na wierzchu ciężkich przedmiotów.
- Nigdy nie pozwalaj dzieciom wspinać się na szuflady, drzwiczki lub półki.
- Używaj mebli zgodnie z ich przeznaczeniem.

EN

WARNING!

Serious or fatal crushing injuries can occur from furniture tip-over.

ALWAYS secure this furniture to the wall using tip-over restraints.

The embedded dowel is used for brick and concrete walls. For wall mounting, use fasteners suitable for the wall material of your home, if you are not sure which type of fastening is suitable for the wall material, contact a specialist or a specialized store. Ultimately, the installer is responsible for the fasteners.

To further reduce the risk of serious injury and death from tip-overs:

- Place heaviest items in the lower drawer.
- Do not heave objects on top of this product.
- Never let children climb or hang on drawers, doors, or shelves.
- Use the furniture for its intended purpose.