

Instructions for assembling furniture Instrukcja montażu mebli

Collection Kolecja mebli
«DIESEL»

Bed 90-2
Łóżko 90-2

AH-029.39.00.00

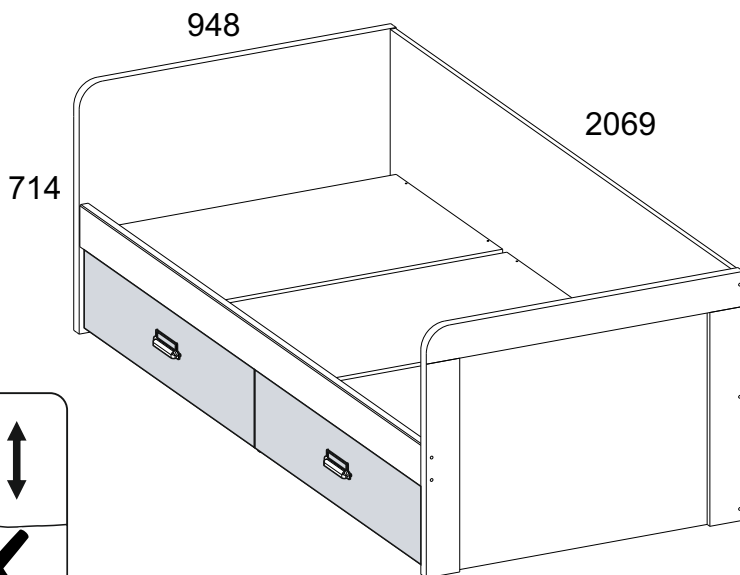

Production date
Data produkcji

Stamp of Quality Department
Pieczęć Działu Jakości

PL

Przy eksploatacji mebli zabrania się:

- ustawiać meble w pobliżu grzewczych przyrządów i obok wilgotnych ścian, a także w pomieszczeniach ze względną wilgotnością więcej niż 70%;
- temperatura nagrzewania elementów mebli nie może przekraczać +40°C;
- w trakcie montażu i eksploatacji mebli stawać nogami na poziome panele i witryny;
- stosować chemiczne środki czyszczące do sprzątania mebli;
- nie należy narażać na kontakt z wodą.

Gwarancje producenta.

1. Gwarancyjny termin eksploatacji wyrobu - 24 miesiące z dnia sprzedaży. W okresie gwarancyjnego terminu producent gwarantuje naprawę wyrobów lub ich zamianę, jeżeli reguły eksploatacji nie zostały naruszone przez nabywcę.
2. Roszczenia są przekazywane przez nabywcę bezpośrednio do handlującej organizacji, w której były nabyte meble, tylko przy okazaniu danej "Instrukcji montażu" wraz z dokumentem zakupu.
3. Wyrób **Łóżko 90-2**, wchodzące w zestaw mebli „**DIESEL**”, odpowiada wymaganiom Norm Państwowych 19917-2014, TP TC 025/2012
4. Trwałość użytkowa mebli - 5 lat.
5. Firma-producent pozostawia za sobą prawo do wprowadzania zmian w konstrukcje wyrobów, nie pogarszając ich konstruktywne i eksploatacyjne charakterystyki.
6. Do montażu wyrobów zaleca się skorzystanie z pomocy wykwalifikowanych specjalistów.

Zapach.

Nowe meble mogą wydzielać zapach materiałów, z których są wykonane. Zapach może utrzymywać się do trzech tygodni od momentu montażu. Aby zmniejszyć intensywność zapachu, zaleca się:

- w przypadku mebli tapicerowanych - odkurzyć produkt i przewietrzyć pomieszczenie. Powtarzaj 3-4 razy dziennie.
- dla mebli szafkowych - przetrzyj ściereczką zwilżoną łagodnym detergentem, przetrzyj czystą, suchą ściereczką i przewietrz pomieszczenie, uprzednio otwierając wszystkie drzwi i szuflady produktu. Powtarzaj 3-4 razy dziennie.

Ważne! Proszę zachować instrukcję w razie ponownego montażu mebli lub reklamacji. Podczas składania reklamacji prosimy o korzystanie z oznaczeń z instrukcji.

EN

Instruction manual.

It's advised to check the quality and completeness of the product in the store when buying unpacked. Assembling of the product should be done the way it's described in this manual. While the product is in service loose screw connections should be periodically tightened. If it's necessary to move items around the apartment before moving you should release the product completely from the load (the mattress). To prevent damage to existing supports the product should be lifted before moving. Furniture should not be exposed to contact with water. Dusting the product should be done with a slightly damp soft cloth. To prevent warping of parts and discoloration of products do not install furniture in direct sunlight.

While the product is in service it's PROHIBITED TO:

- Install furniture near heating devices, close to the raw walls and in rooms with a relative humidity of more than 70%;
- heat elements of furniture to the temperature higher +40°C;
- step on the horizontal shields and windows during assembly and use of the products set;
- use chemical cleaners for cleaning furniture.

Manufacturer's warranty.

1. The warranty period of use of the product - 24 months from the date of sale. During the warranty period the manufacturer guarantees repair or replacement of products, if the user has not violated operating rules.
2. Claims should be made by the consumer directly to the trading organization, in which furniture was purchased, presenting the "Instruction manual" and a copy of the sales receipt.
3. The product **Bed 90-2**, which is part of a set of „**DIESEL**”, meet the requirements of GOST 19917-2014, TR TS 025/2012.
4. The lifetime of furniture - 5 years.
5. The manufacturer reserves the right to make changes in product design, without compromising its design and application requirements.
6. To assemble the products it's recommended to attract qualified personnel.

Smell.

New furniture may emit the smell of the materials from which it is made. The smell can persist for up to three weeks from the time of assembly. To reduce odor intensity, it is recommended:

- for upholstered furniture - vacuum the product and ventilate the room. Repeat 3-4 times a day.
- for cabinet furniture - wipe with a cloth dampened in a mild detergent, wipe with a clean, dry cloth and ventilate the room, previously opening all doors and drawers of the product. Repeat 3-4 times a day.

It is important! Keep the instruction in case of reassembly of furniture or complaint. When making a claim use the notation from the instruction.

№	L, mm	B, mm	H, mm	Q	№ pack
1	948	710	32	1	2/3
2	948	710	32	1	2/3
3	708	2005	16	1	3/3
4	120	2005	28	1	3/3
5	900	40	16	4	3/3
9*	998	230	16	2	1/1
10	600	180	16	2	3/3
11	600	180	16	2	3/3
12	912	180	16	2	3/3
13	600	100	16	4	1/3
14	900	290	16	1	1/3
17	898	625	16	3	1/3
18	942	605	2,5	2	1/3
20	500	60	16	3	3/3

*There is an option of ordering fronts in various colours.



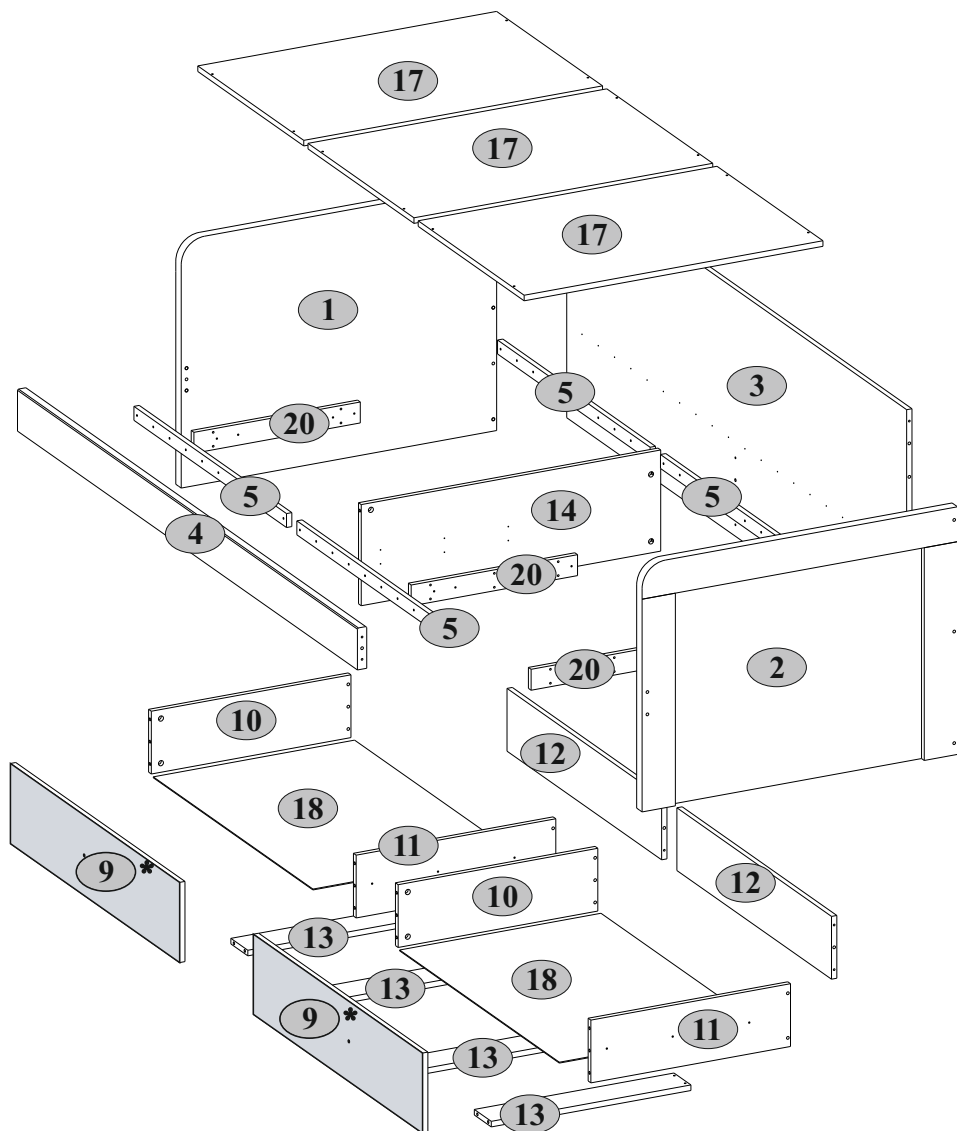









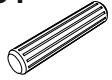



*Jest opcja zamówienia frontów w różnych kolorach.

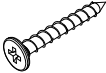

*There is an option of ordering fronts in various colours.

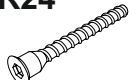
*Jest opcja zamówienia frontów w różnych kolorach.

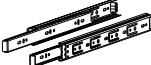

A1.0  5x28 15	A2  Ø15x13 15	C1  8x35 22	H24  2
I  S4 1	M14  M4x14 4	N1  9	Q  1,5x7 4
R3  3x20 24	R10  4x30 58	R11  4x35 12	R12  4x40 8
R24  7x50 8	R25  7x70 10	R27  5,0x13 28	S5  Ø18 8
S8  Ø14 10	Z14  500 2		

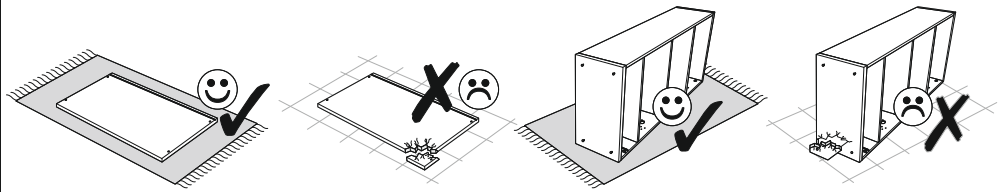
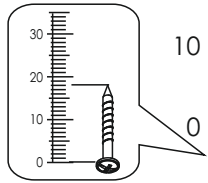
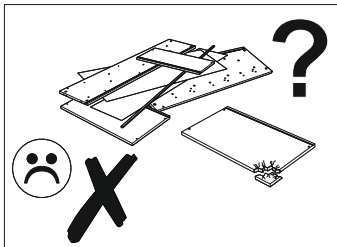
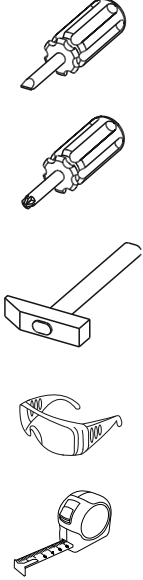
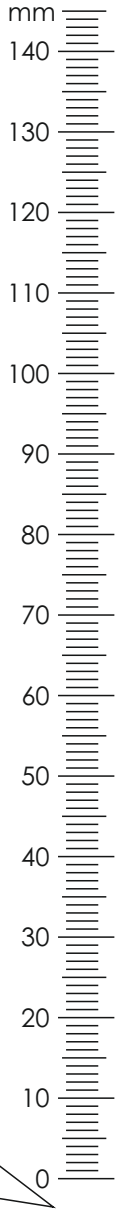

1

A1.0



5x28

C1

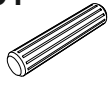

3 8x35

N1



8

R10



3 4x30 40

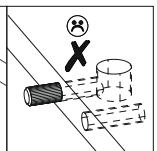
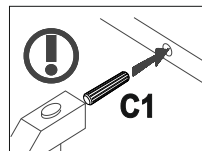
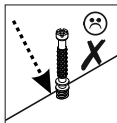
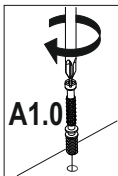
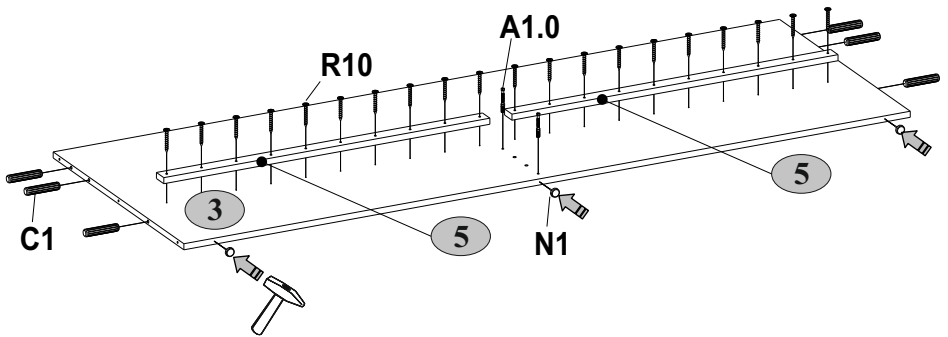
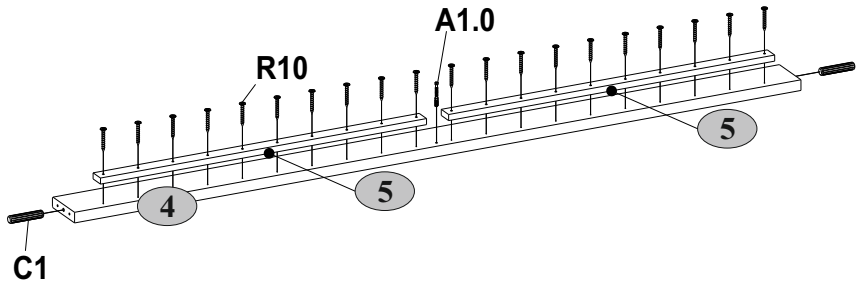



2

A2

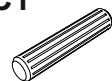
 Ø15x13 3

C1

 8x35 2

N1

 6

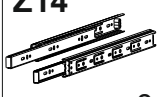
R10

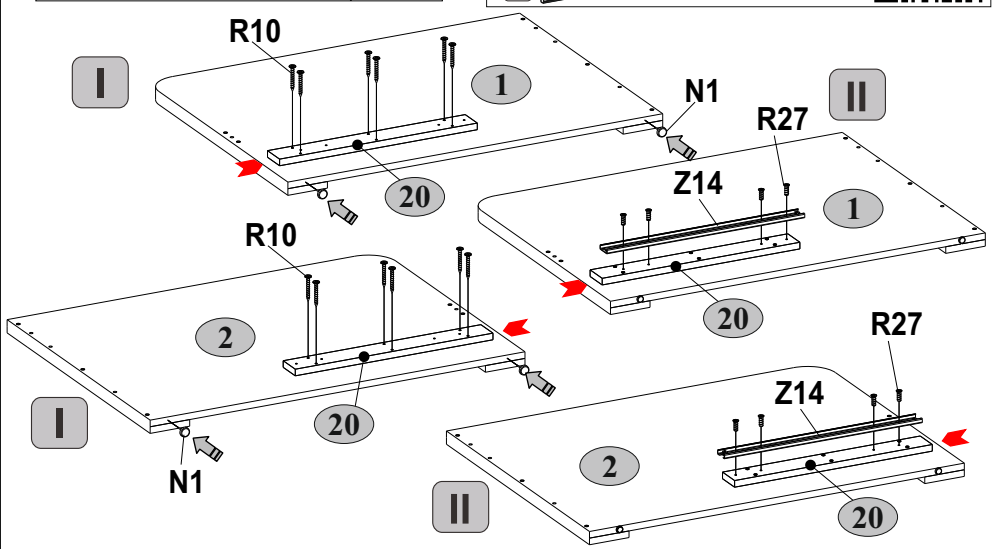
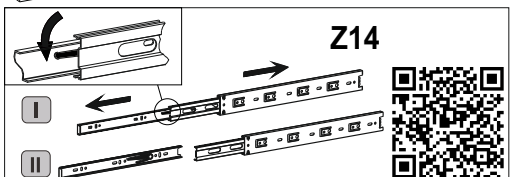
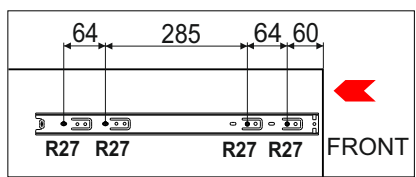
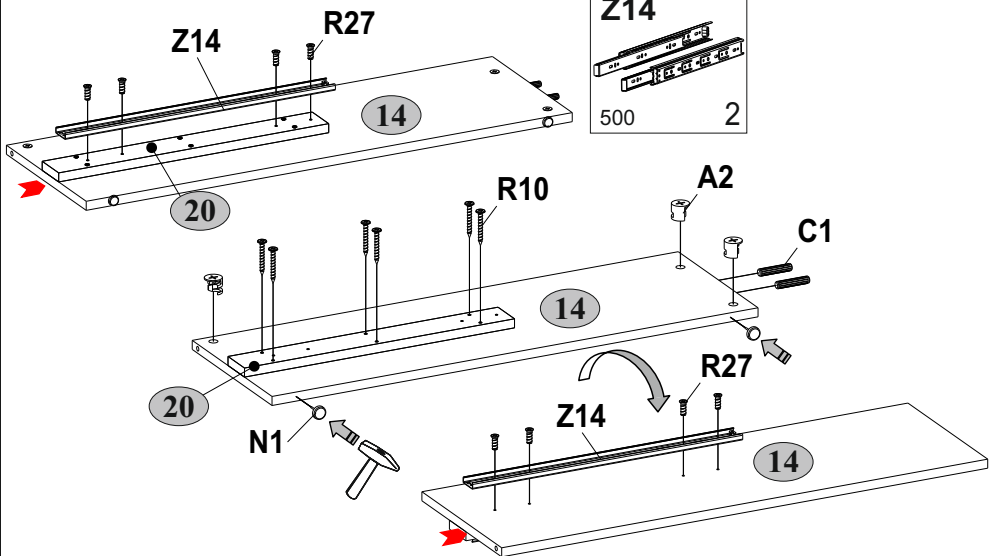
 4x30 18

R27

 5,0x13 16

Z14

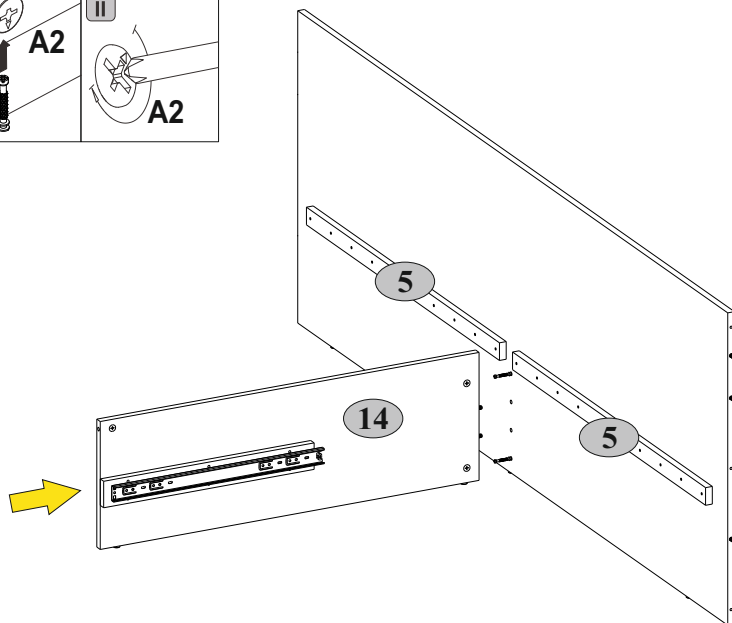
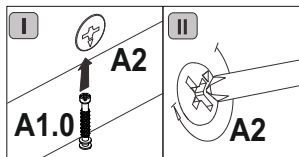
 500 2



3

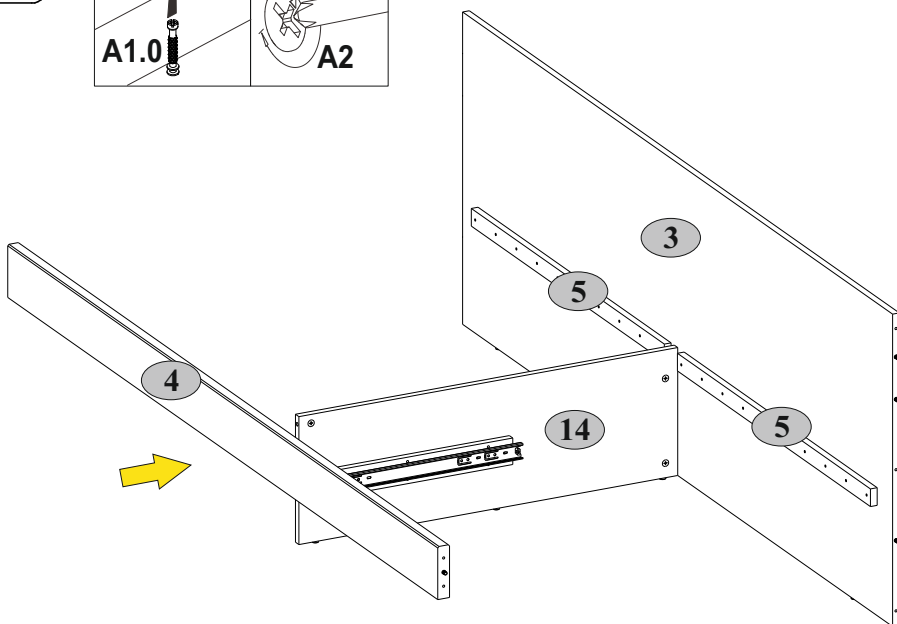
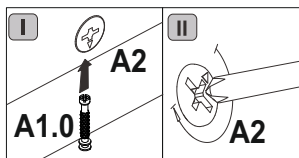

4



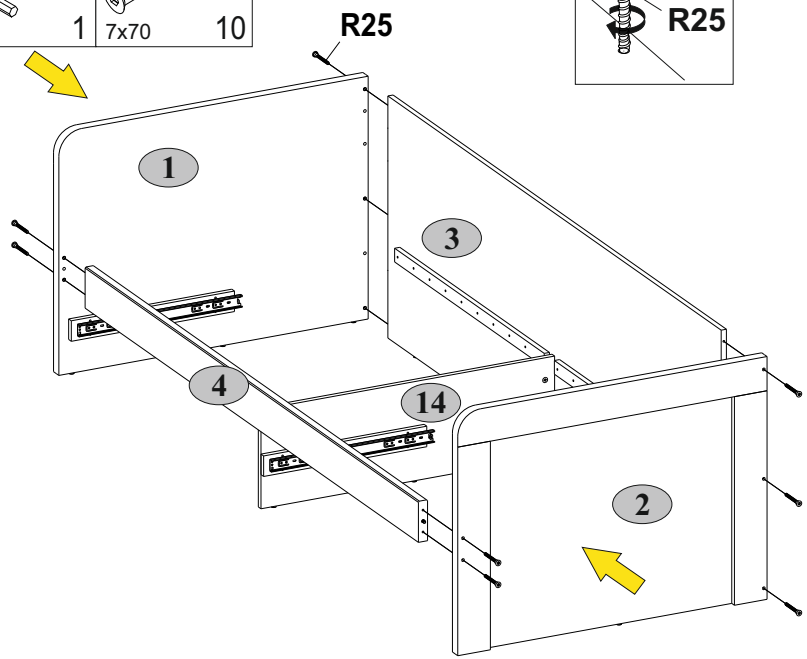
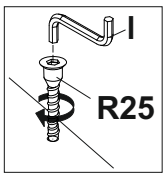
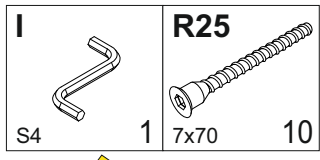

5

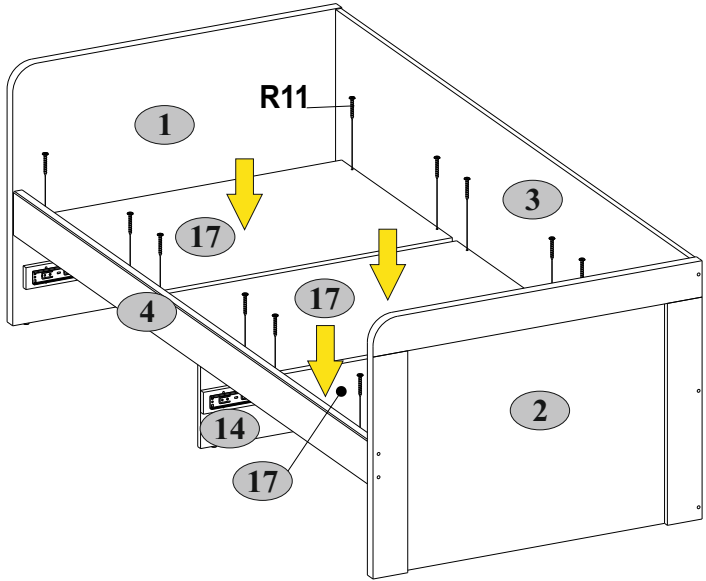
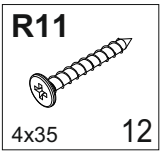

6



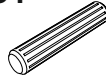

7

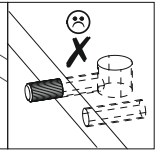
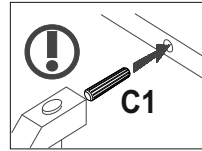
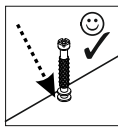
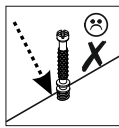
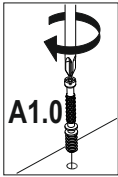
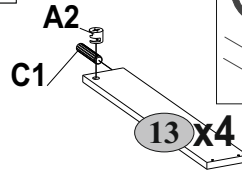
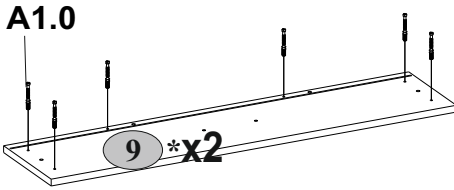
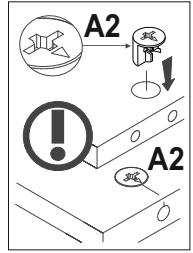
A1.0  5x28 12	A2  Ø15x13 4	C1  8x35 4
---	--	--

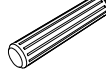
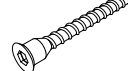

8

x2

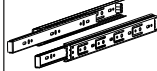
A2  Ø15x13 8	C1  8x35 8	R24  7x50 8	R27  5,0x13 12	Z14  500 2
--	--	---	--	--

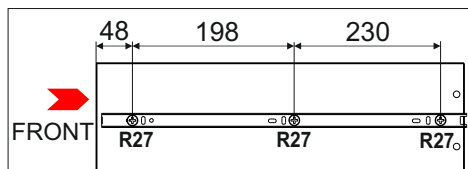
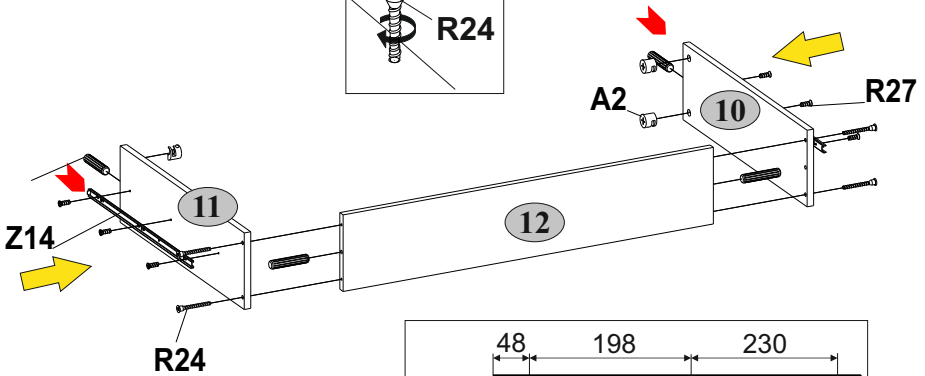
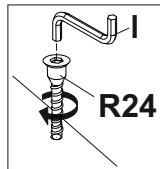

9
x2

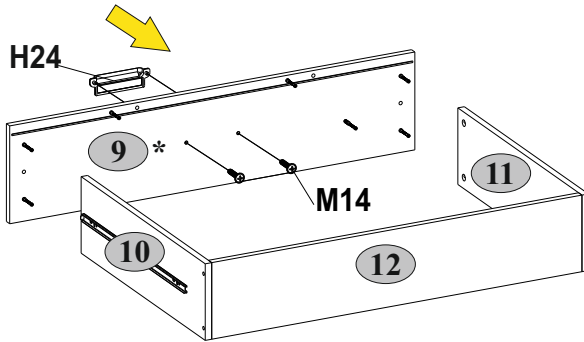
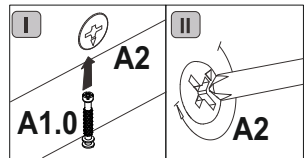
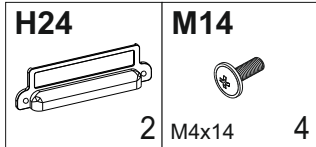

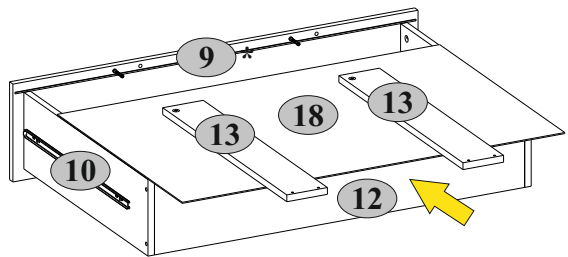
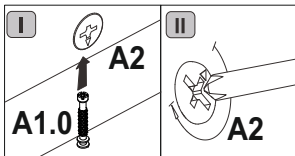

10
x2

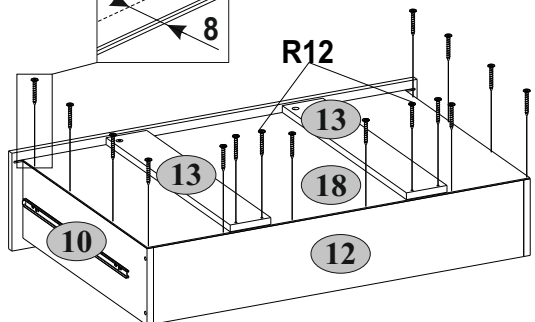
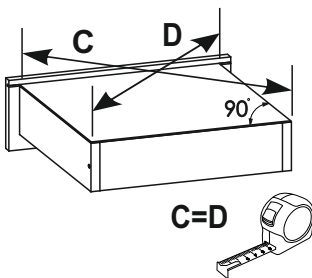
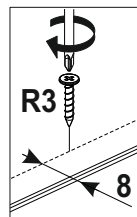
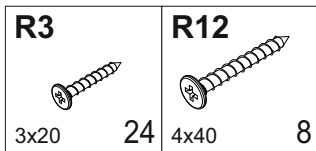

11
x2



12

Q  1,5x7	S5  4 Ø18	S8  8 Ø14
--	---	---

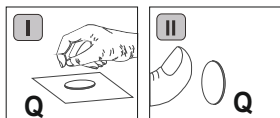
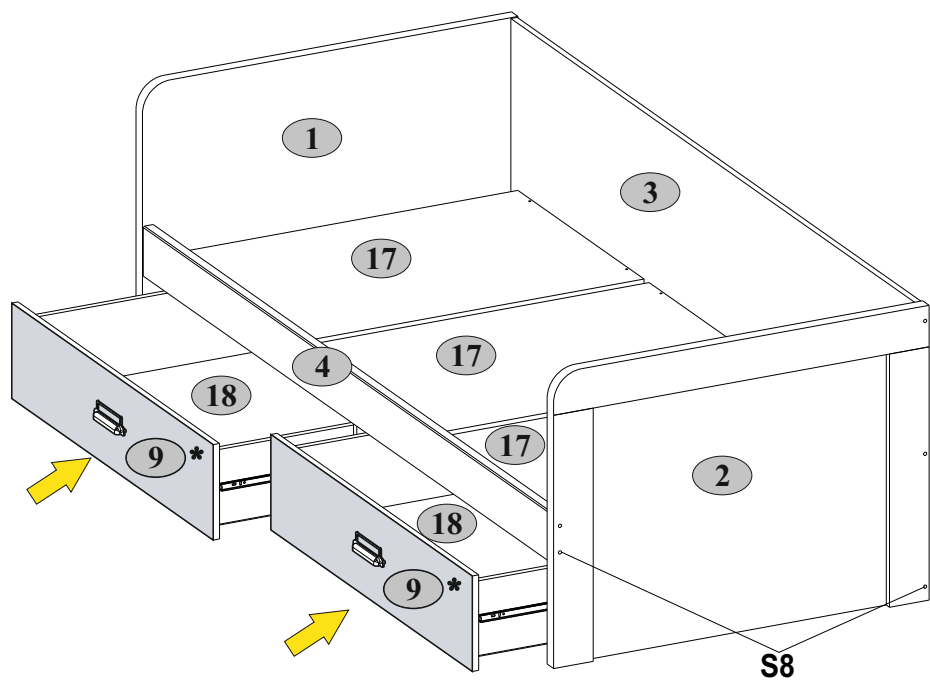
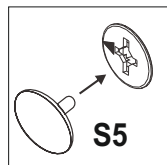
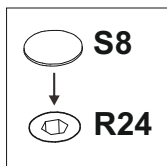

18  max. 5 kg

17  max. 90 kg